



STEEL STAR
www.greatforming.com



15 Yılı Aşkın Rulo Şekillendirme Makinesi Deneyimi



Şeffaf Planlar, Şeffaf Fiyatlar.
Size En Uygun Planı Oluşturun.

Rulo Şekillendirme Makinesi

CANGZHOU STEELSTAR MACHINERY CO.,LTD.

İçindekiler



Şirket Profili



Yabancı Ortaklar



Sergiler



STEEL STAR
www.greatforming.com



Ürün Katalođu

1. Çatı Sac Rulo Şekillendirme Makinesi
2. Hafif Omurga Saplaması ve Palet Rulo Şekillendirme Makinesi
3. Panjur Kapı Rulo Şekillendirme Makinesi
4. C/Z Aşık Rulo Şekillendirme Makinesi
5. Çatı Mahyası Şekillendirme Makinesi
6. Varil Oluklu Rulo Şekillendirme Makinesi
7. Zemin Kaplama Rulo Şekillendirme Makinesi
8. Otomobil Karton Rulo Şekillendirme Makinesi
9. Yağmur Olukları / İniş Boruları Rulo Şekillendirme Makinesi



STEEL STAR
www.greatforming.com



Ürün Katalođu

10. Hafif Keel Villa Çerçeve Rulo Şekillendirme Makinesi
11. Korkuluk Plakası Rulo Şekillendirme Makinesi
12. EPS Köpük/Taş Yünü Çatı Levhası Kompozit Üretim Hattı
13. (PU)Poliüretan Sandviç Panel Üretim Hattı
14. Tavan Paneli Açma Makinesi / Otomatik İstifleme Makinesi
15. Bükme / Giyotin Kesme Makinesi
16. Çelik Bobin Dilme Hattı Makinesi
17. Güneş Paneli Braketi Makinesi
18. Çelik Boru Üretim Makinesi



STEEL STAR
www.greatforming.com



Ürün Katalođu

19. Raflı Rulo Şekillendirme Makinesi
20. Kablo Kanalı Rulo Şekillendirme Makinesi
21. Metal Kabartma Hattı
22. Çit Diređi / Çit Çubukları Rulo Şekillendirme Makinesi
23. Silo Rulo Şekillendirme Makinesi
24. Ayak Pedallı Rulo Şekillendirme Makinesi
25. Dik Dikişli Rulo Şekillendirme Makinesi
26. Taş Kaplı Çatı Kiremiti Üretim Makinesi
27. Çeşitli Ürünler Kişiselleştirilebilir

İçindekiler



Yurtdışına Nakliye



Hizmet



Bize Ulaşın



STEEL STAR
www.greatforming.com

Şirket Profili

Fabrika 20.000 m²'lik bir alanı kapsıyor.

Gerçek üretim fabrikası

24 saat çevrimiçi hizmet

15 yıllık sektör deneyimi

30'dan fazla ülkeyle işbirliği yapıldı.

Şeffaf Planlar Şeffaf Fiyatlar

Alman kopra tasarım yazılımı



Birçok yabancı ortağı var.

Çeşitli uluslararası sertifikalar edindi.



STEEL STAR
www.greatforming.com

Şirket Fabrika Görünümü

Fabrika Bölgesi



Ham Madde İşleme Atölyesi



Montaj Üretim Atölyesi





STEEL STAR
www.greatforming.com

Alman Hindistan Cevizi Tasarım Yazılımı

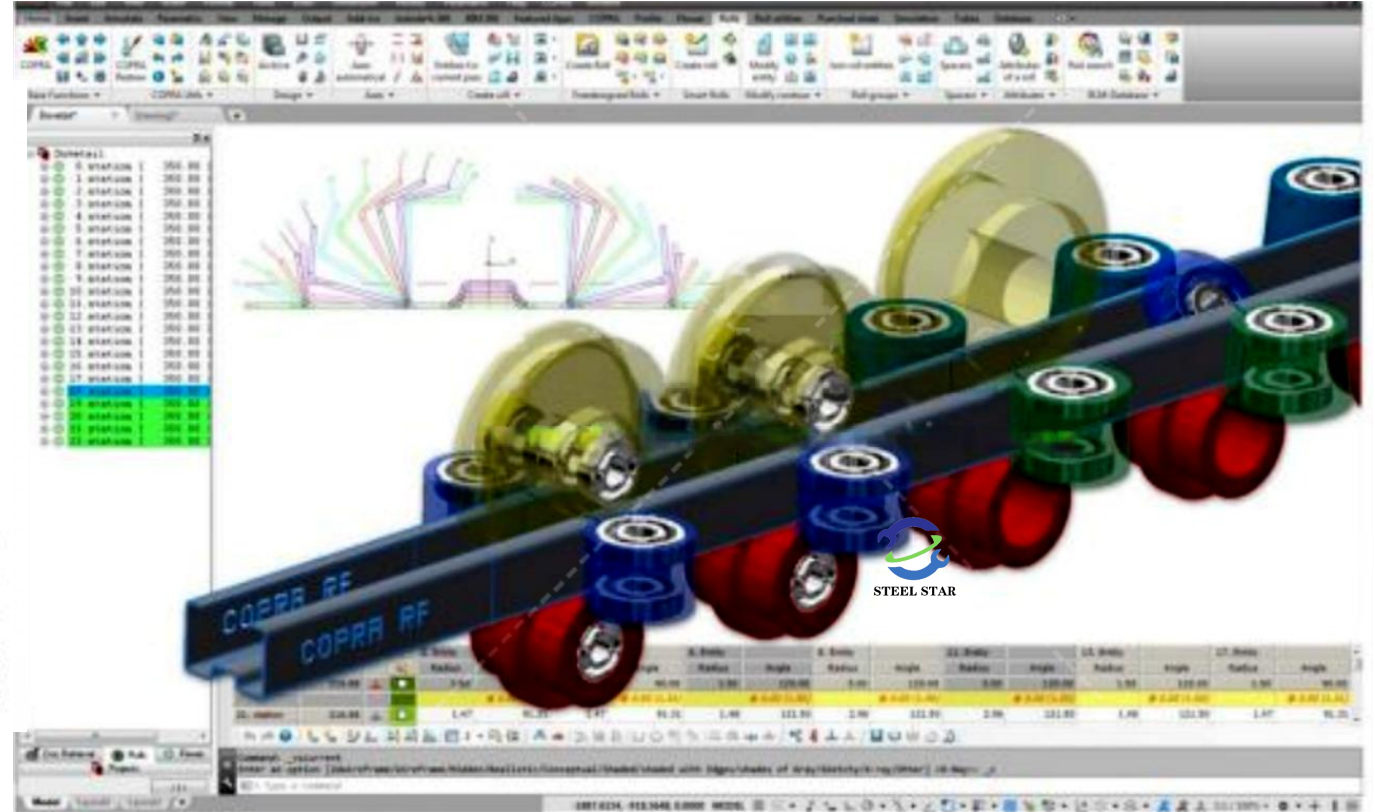
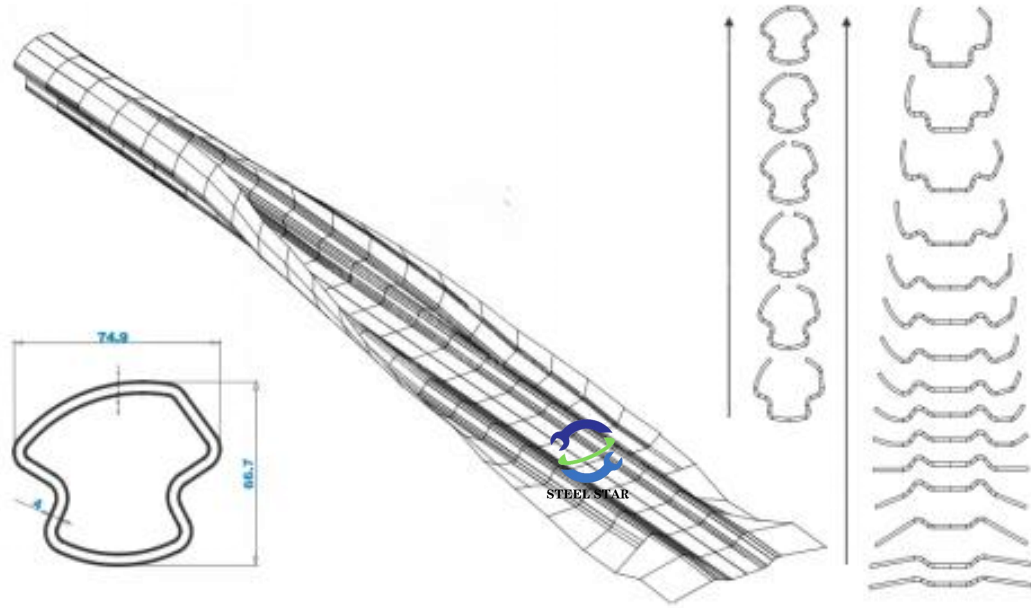



STEEL STAR
www.greatforming.com

Şirket Onur Belgesi





STEEL STAR
www.greatforming.com

Yabancı Ortaklar





STEEL STAR
www.greatforming.com

Sergiler

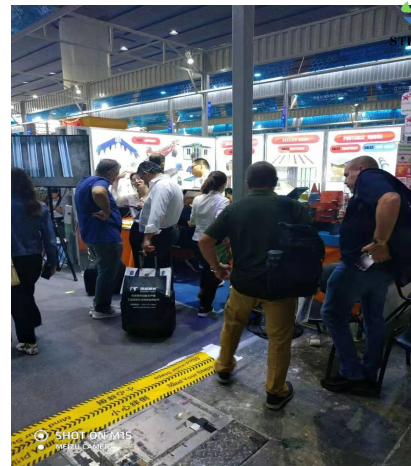
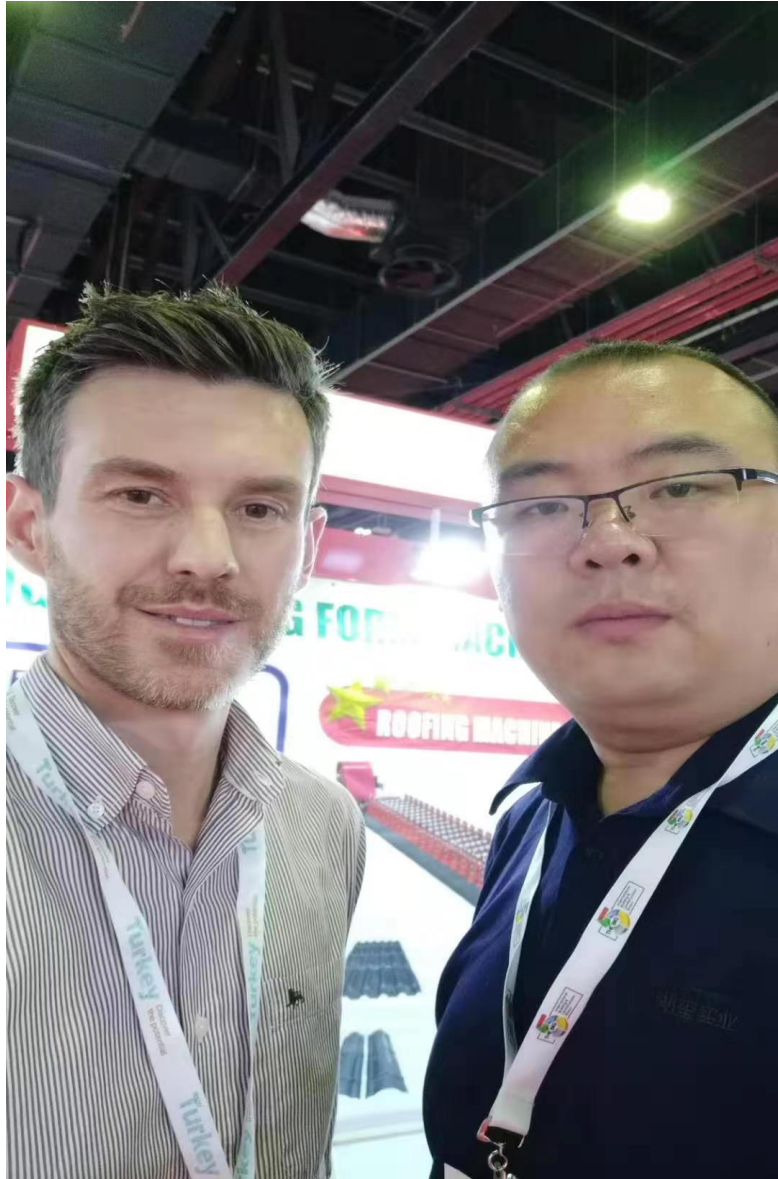



Ürün Katalođu

1. Çatı Sac Rulo Şekillendirme Makinesi

STEEL STAR
www.greatforming.com

1-1 Tek Modelli Trapezoidal Çatı Sacı Rulo Şekillendirme Makinesi

Uygulama Senaryoları

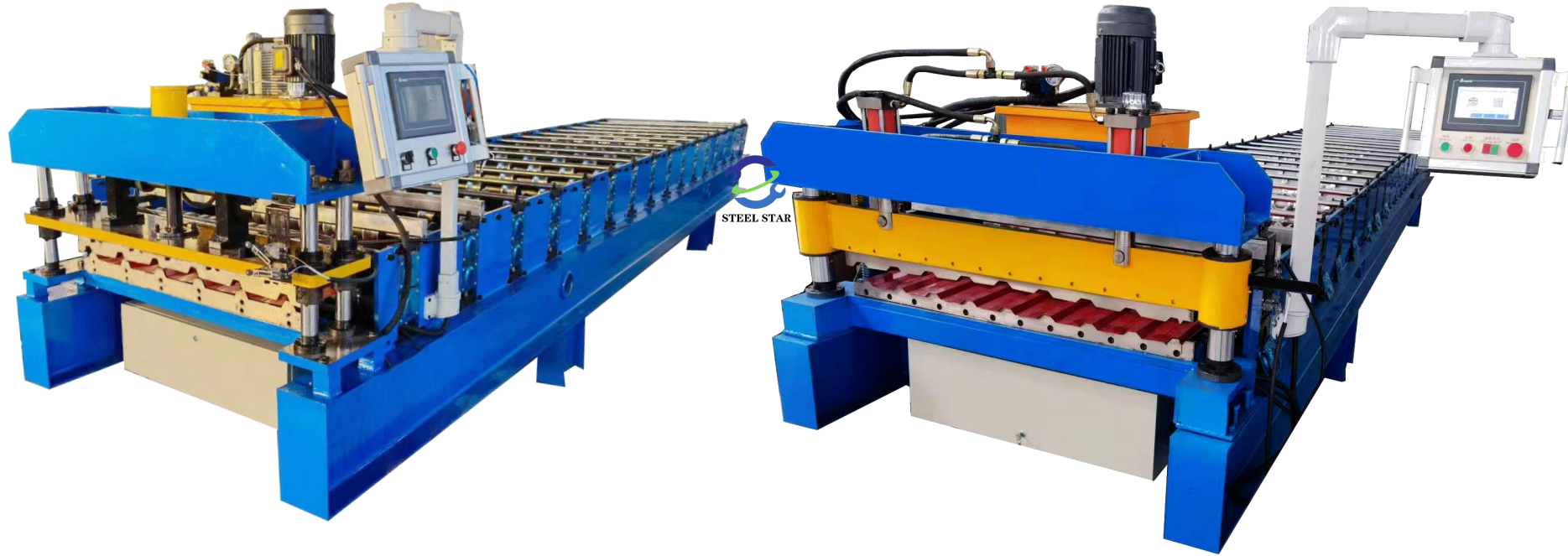



1-1 Tek Modelli Trapezoidal Çatı Sacı Rulo Şekillendirme Makinesi

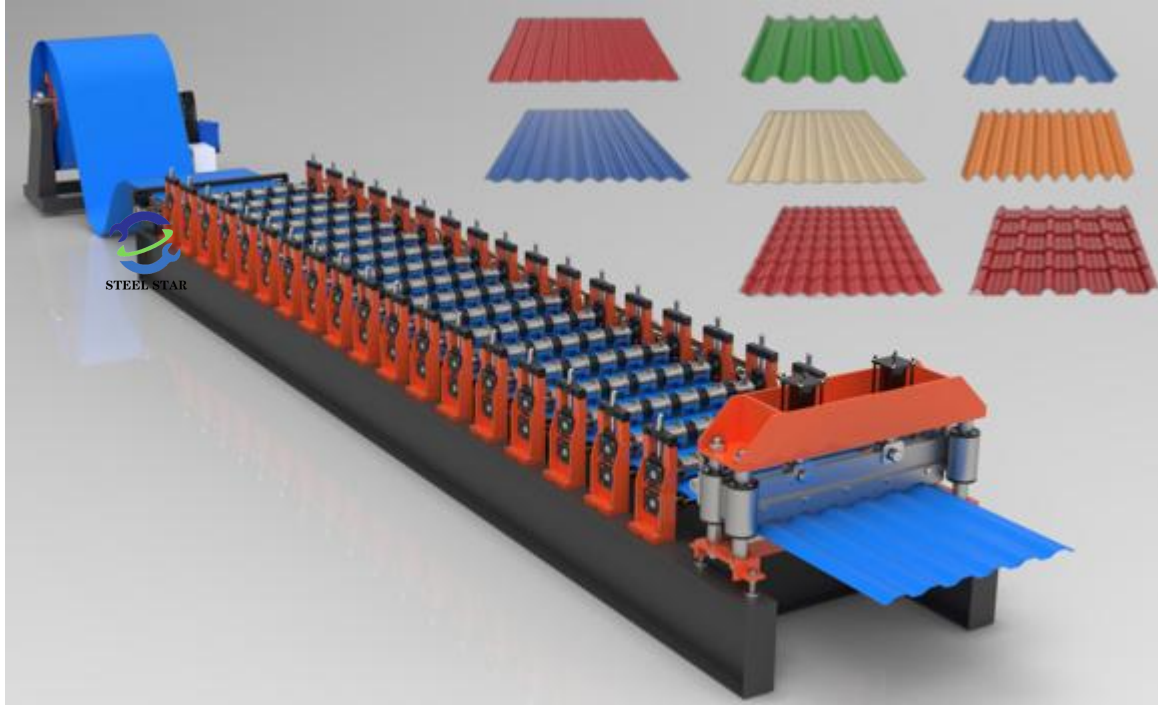

Trapezoidal roofing sheet

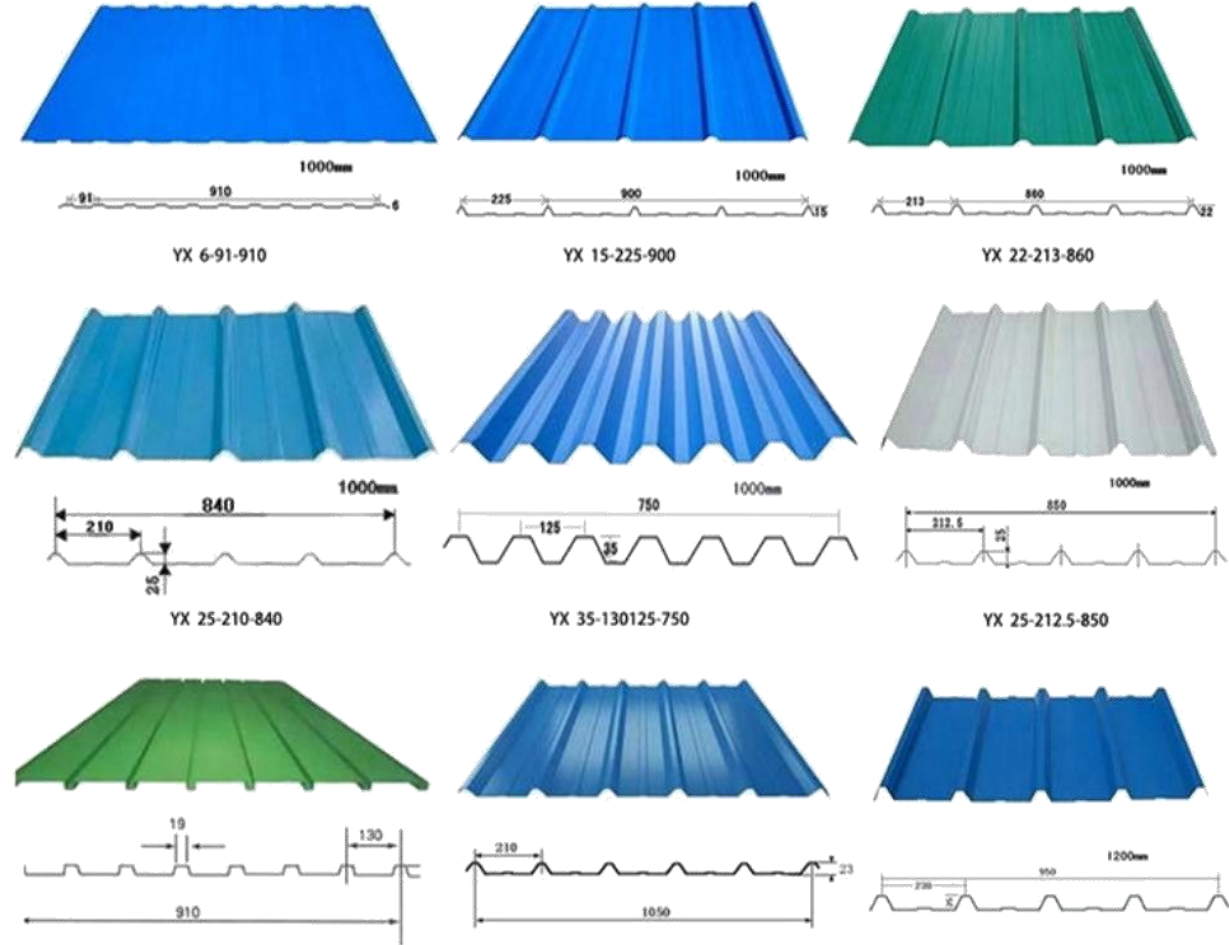



Ürün Katalođu

1. Çatı Sac Rulo Şekillendirme Makinesi

STEEL STAR
www.greatforming.com

1-2 Tek Modelli Oluklu Çatı Sacı Rulo Şekillendirme Makinesi

Uygulama Senaryoları





1-2 STek Modelli Oluklu Çatı Sacı Rulo Şekillendirme Makinesi

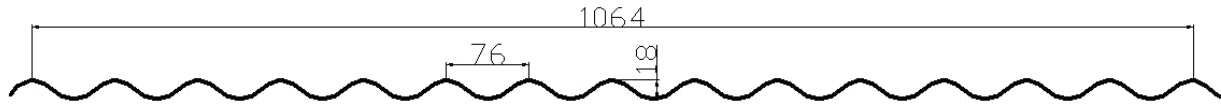

进料宽度: 1250mm

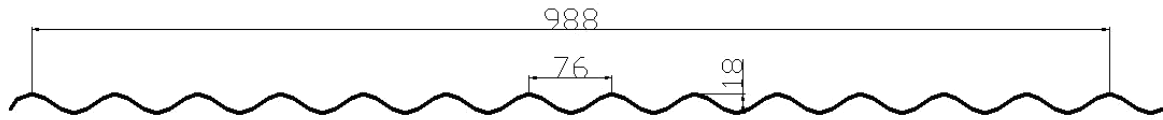

进料宽度: 1200mm

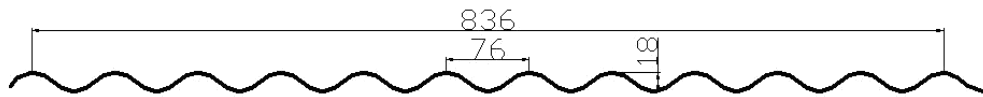

进料宽度: 1000mm

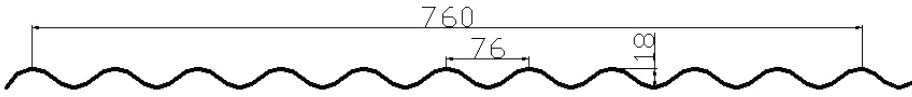

进料宽度: 940mm

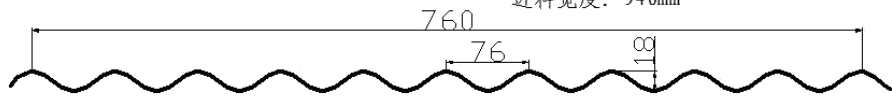

进料宽度: 914mm

Wave roofing sheet

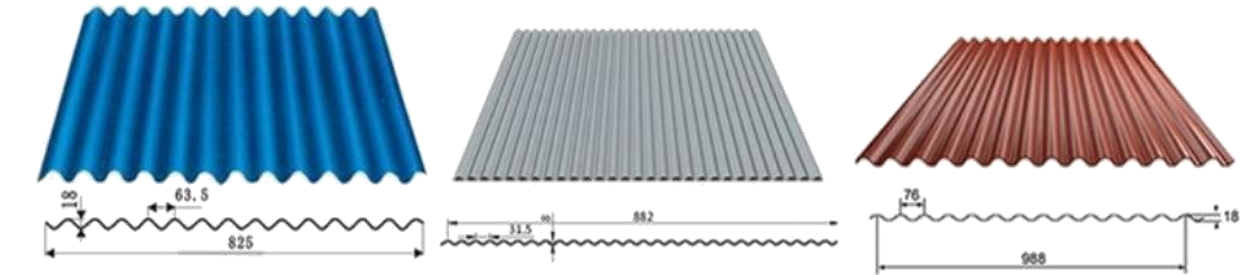

YX 18-63.5-825

YX 8-31.5-882

YX 18-76-988

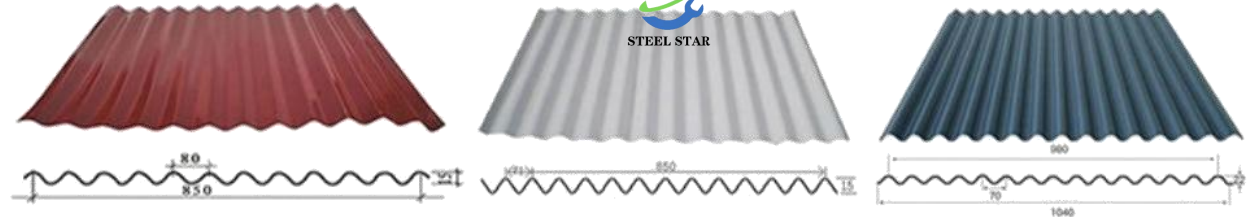

YX 15-80-850

YX 15-71-850

YX 22-70-980

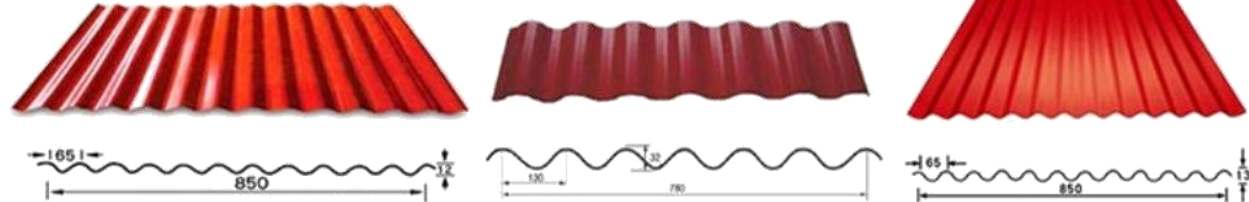

YX 12-65-850

YS 32-130-780

YS 13-65-850



1-3 Tek Modelli Sırlı Kiremit atı Levhası Rulo Őekillendirme Makinesi



Application Scenarios





1-3 Tek Modelli Sırlı Kiremit Çatı Levhası Rulo Şekillendirme Makinesi



Glazed roofing sheet

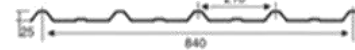

YX 25-210-840

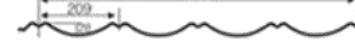

YX 28-29-836



YX 30-126-760

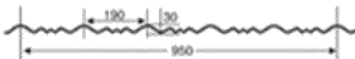

YX 30-190-950



YX 30-177-1060



YX 24-183.5-1100

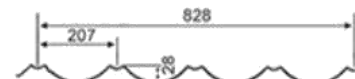

YX 28-207-828

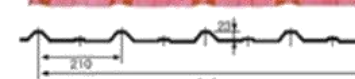

YX 28-207-828

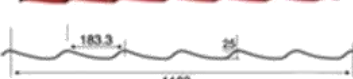

YX 25-183.3-1100



1-4 Çift Katmanlı/Çift Modelli Çatı Sac Levhası Rulo Şekillendirme Makinesi

Application Scenarios

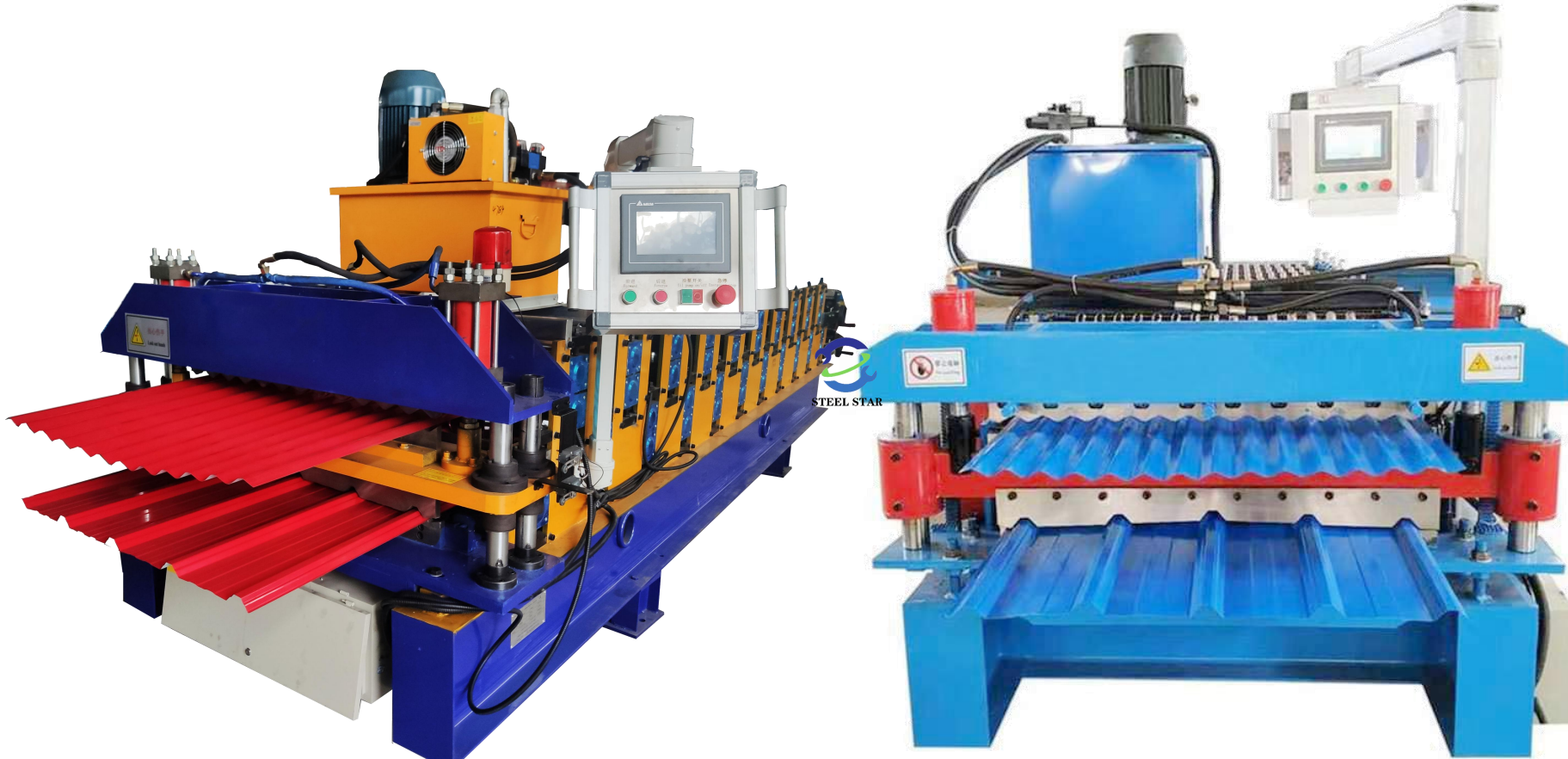



Ürün Katalođu

1. Çatı Sac Rulo Şekillendirme Makinesi

STEEL STAR
www.greatforming.com

1-5 Çift Katmanlı/Çift Modelli Sırlı Kiremit Çatı Levhası Rulo Şekillendirme Makinesi

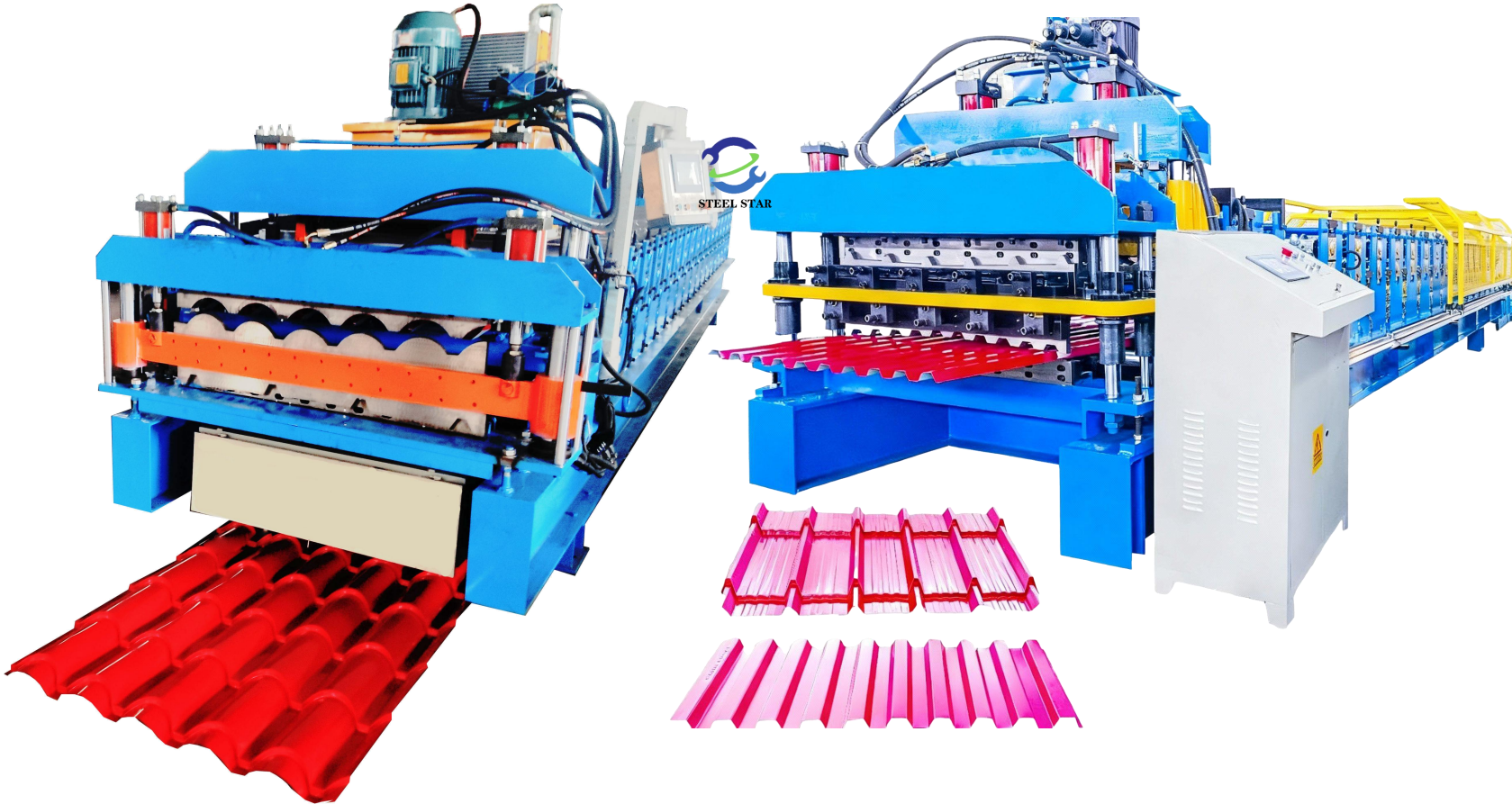

Uygulama Senaryoları





1-6 Üç Katmanlı/Üç Modelli Çatı Sacı Rulo Şekillendirme Makinesi

Uygulama Senaryoları





STEEL STAR
www.greatforming.com

Ürün Katalođu

1. Çatı Sac Rulo Şekillendirme Makinesi

1-7 Çatı Sacı Kemerleme Makinesi

Uygulama Senaryoları

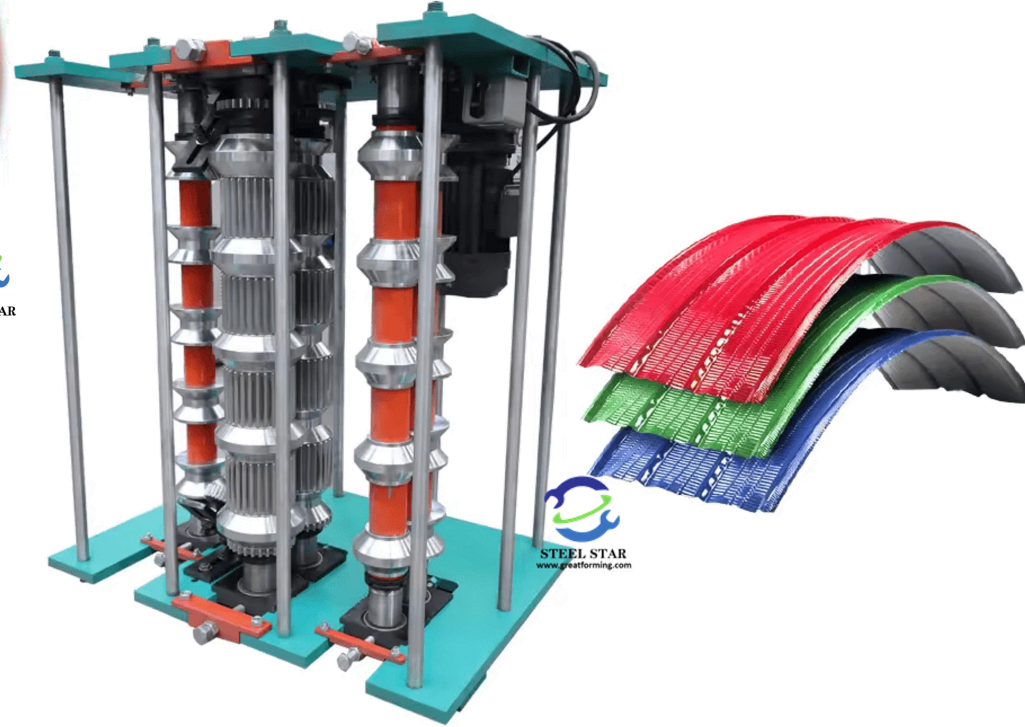
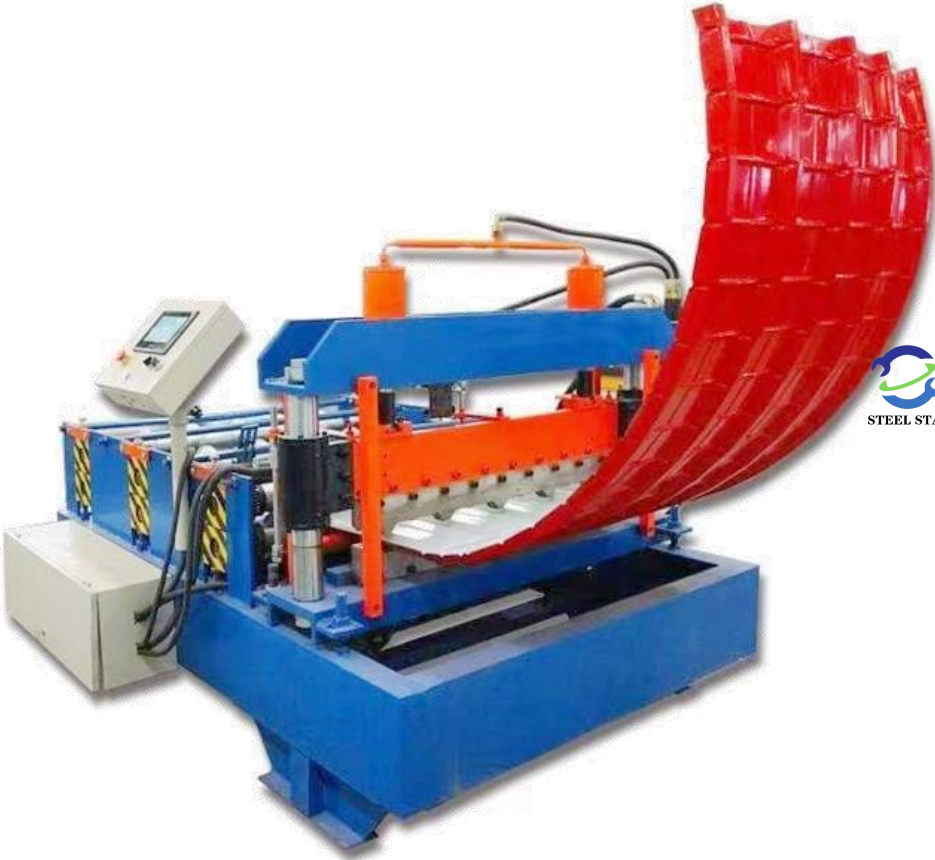



STEEL STAR
www.greatforming.com

Ürün Kataloğu

2. Hafif Omurga Saplaması ve Palet Rulo Şekillendirme Makinesi

2-1 Hafif Omurga Saplaması ve Ray C/U/V/Omega Rulo Şekillendirme Makinesi

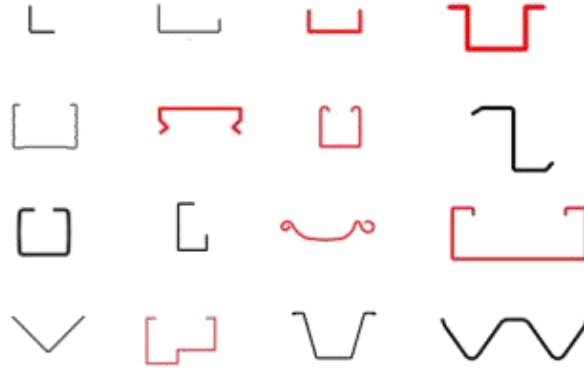
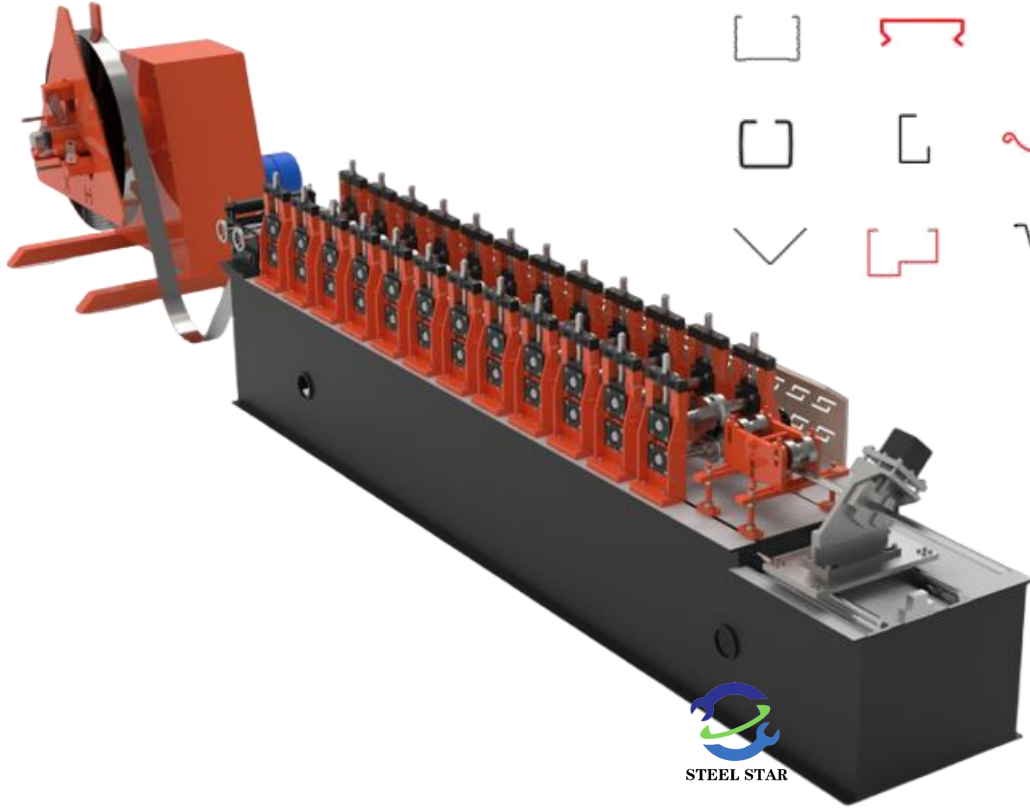

Yüksek hız: dakikada 20-150 metre

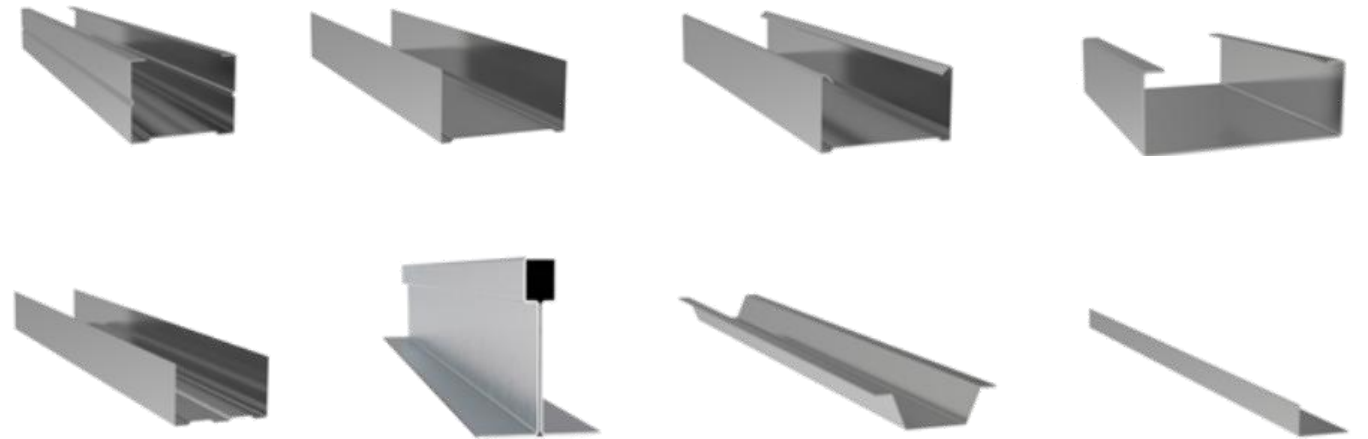

STEEL STAR



STEEL STAR
www.greatforming.com

Ürün Katalođu

2. Hafif Omurga Saplaması ve Palet Rulo Şekillendirme Makinesi

2-1 Hafif Omurga Saplaması ve Ray C/U/V/Omega Rulo Şekillendirme Makinesi

Uygulama Senaryoları

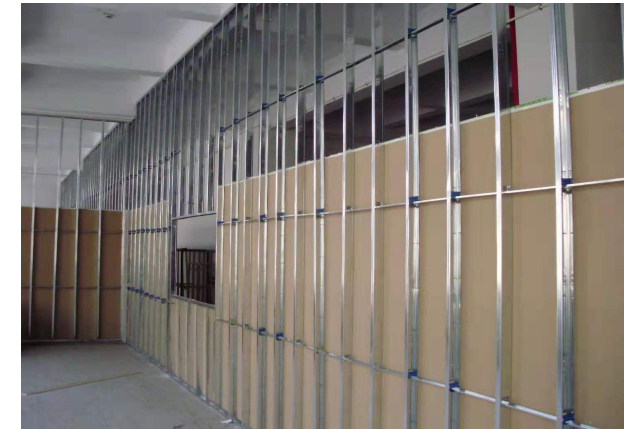



Yüksek Hızlı Hafif Omurga Rulo Şekillendirme Makinesi

STEEL STAR
www.greatforming.com

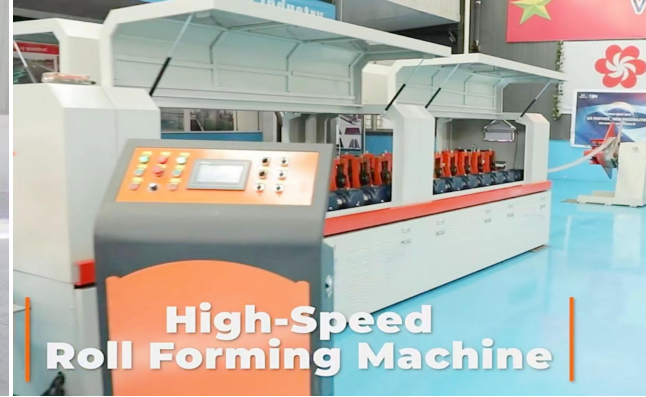

High-Speed
Roll Forming Machine

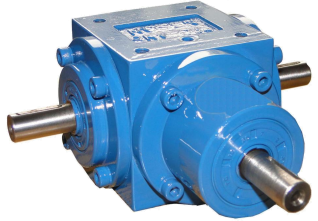

Dişli Kutusu Yapısı



Yüksek Hız 50m-150m/dak

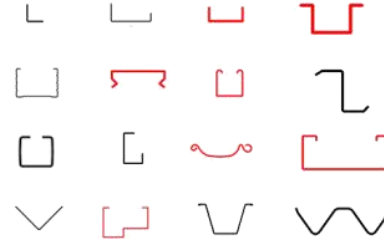

C--Model

U--Model

V--Model

Omega--Model





3. Panjur Kapı Rulo Şekillendirme Makinesi

3-1 Panjur Kapı Rulo Şekillendirme Makinesi

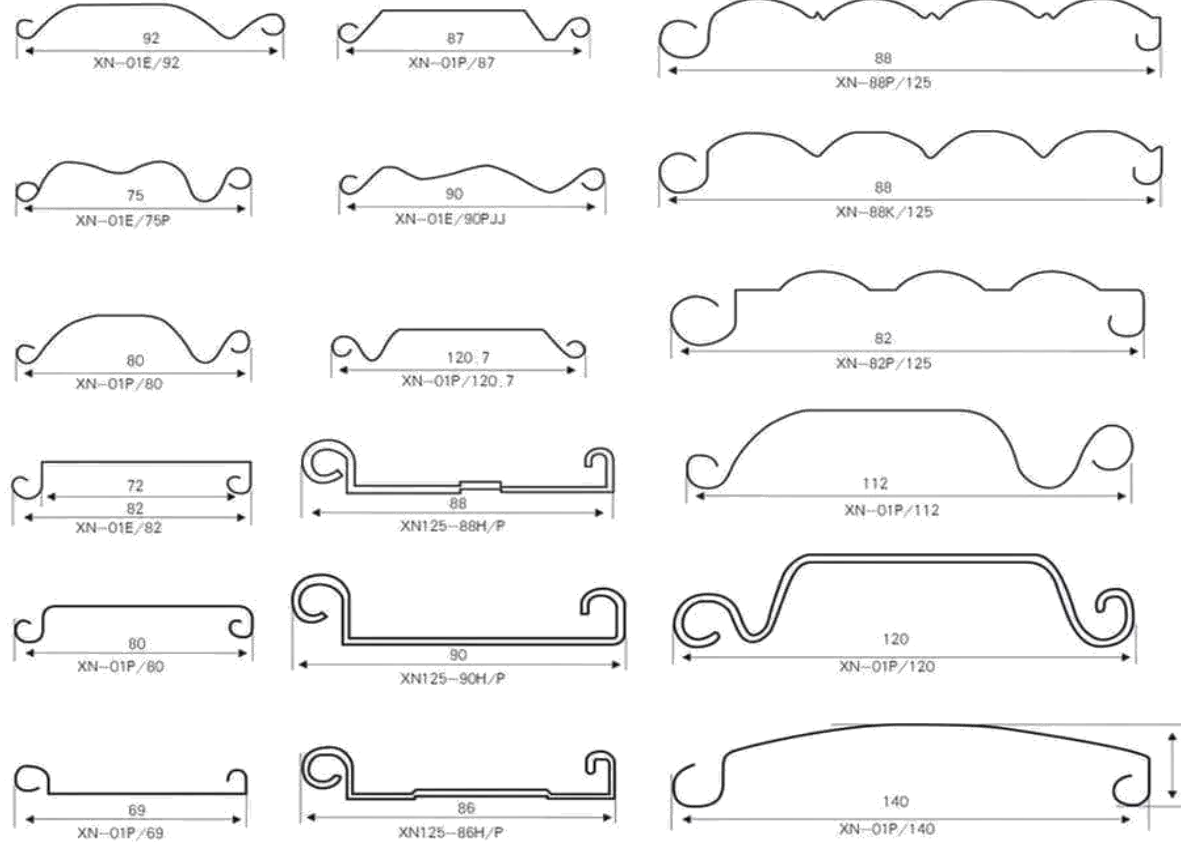
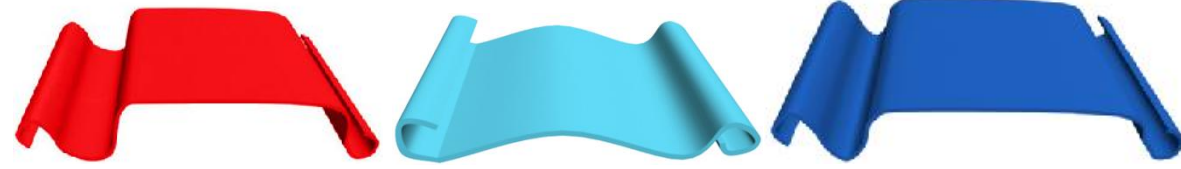
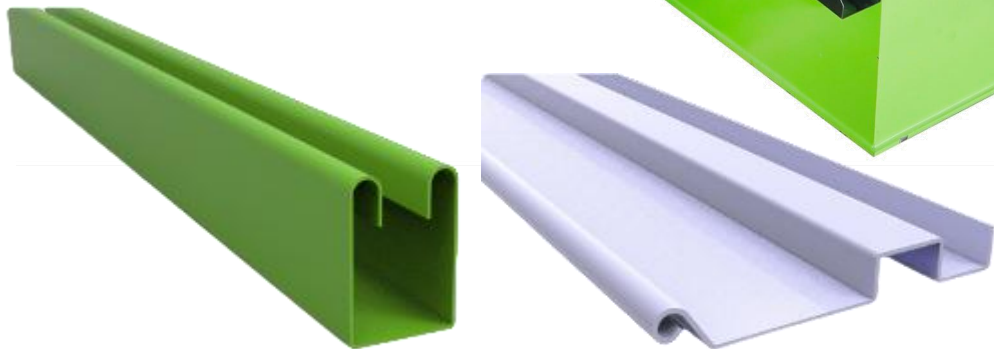



STEEL STAR
www.greatforming.com

Ürün Katalođu

3. Panjur Kapı Rulo Şekillendirme Makinesi

3-1 Panjur Kapı Rulo Şekillendirme Makinesi

Uygulama Senaryoları

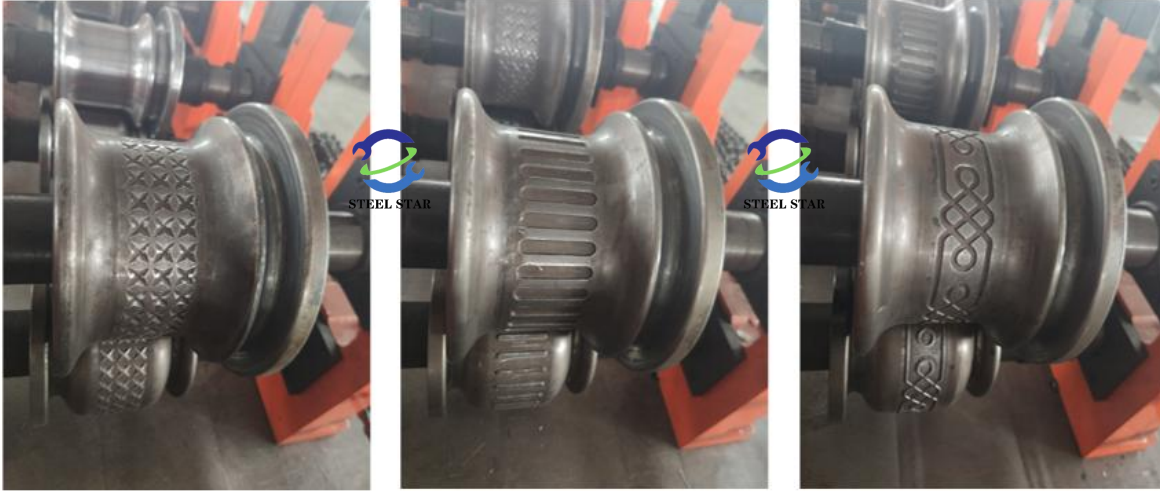



4-1 C/Z Aşık Rulo Şekillendirme Makinesi

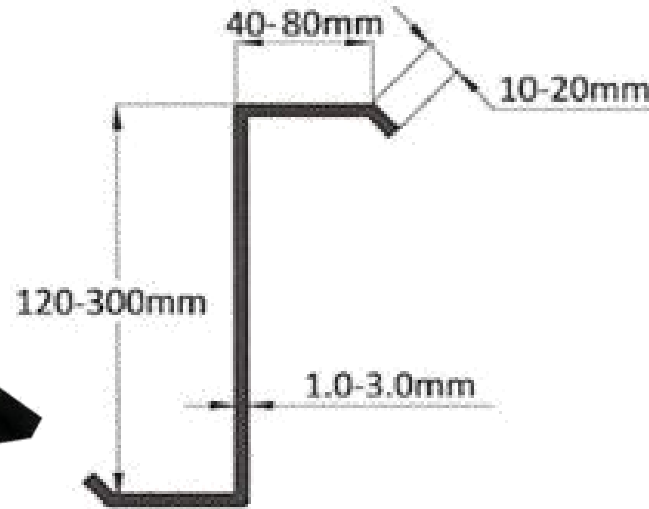
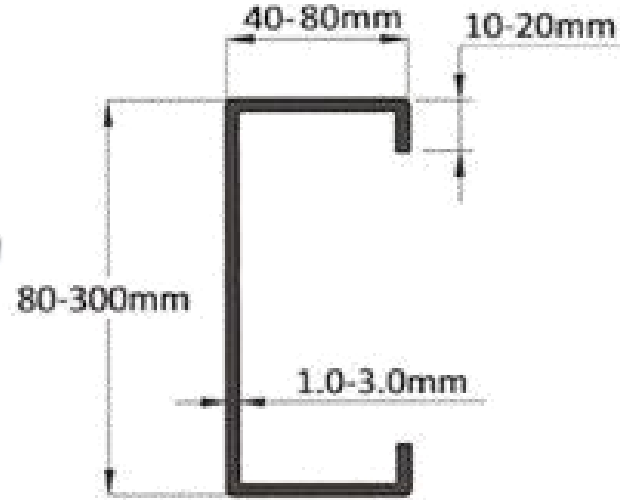

Uygulama Senaryoları

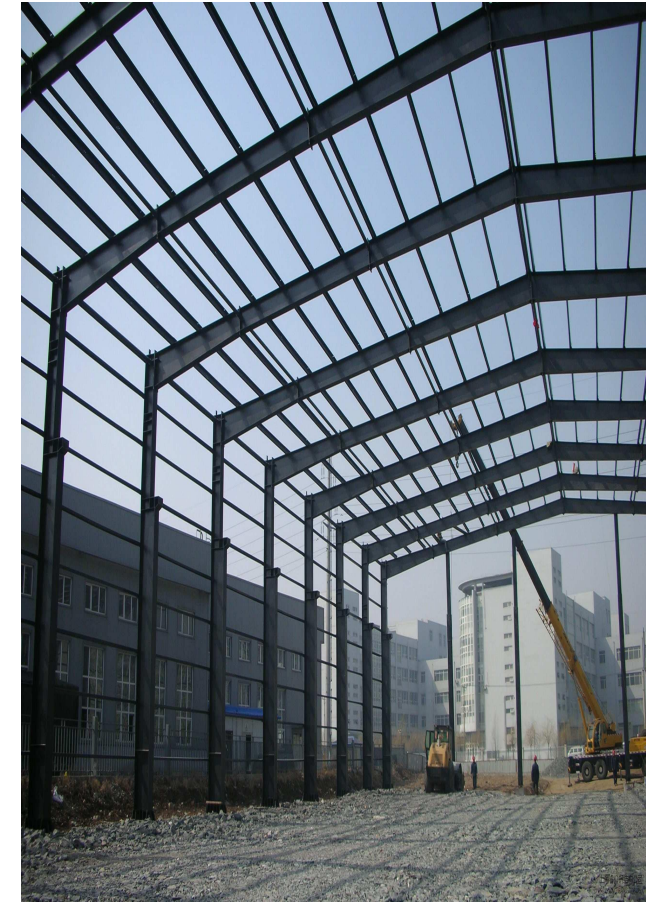



5-1 Çatı Mahyası Şekillendirme Makinesi



Uygulama Senaryoları

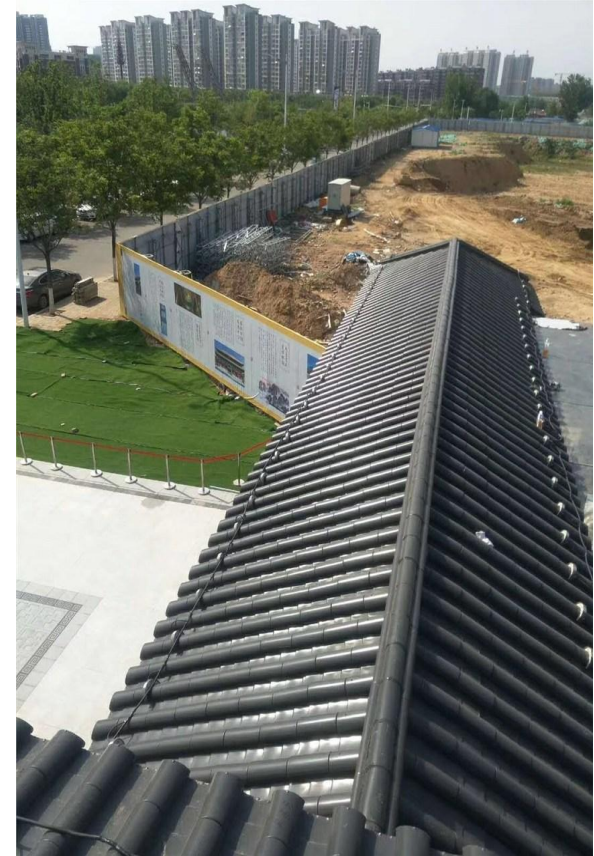



STEEL STAR
www.greatforming.com

Ürün Katalođu

6. Varil Oluklu Rulo Şekillendirme Makinesi

6-1 Varil Oluklu Rulo Şekillendirme Makinesi

Uygulama Senaryoları

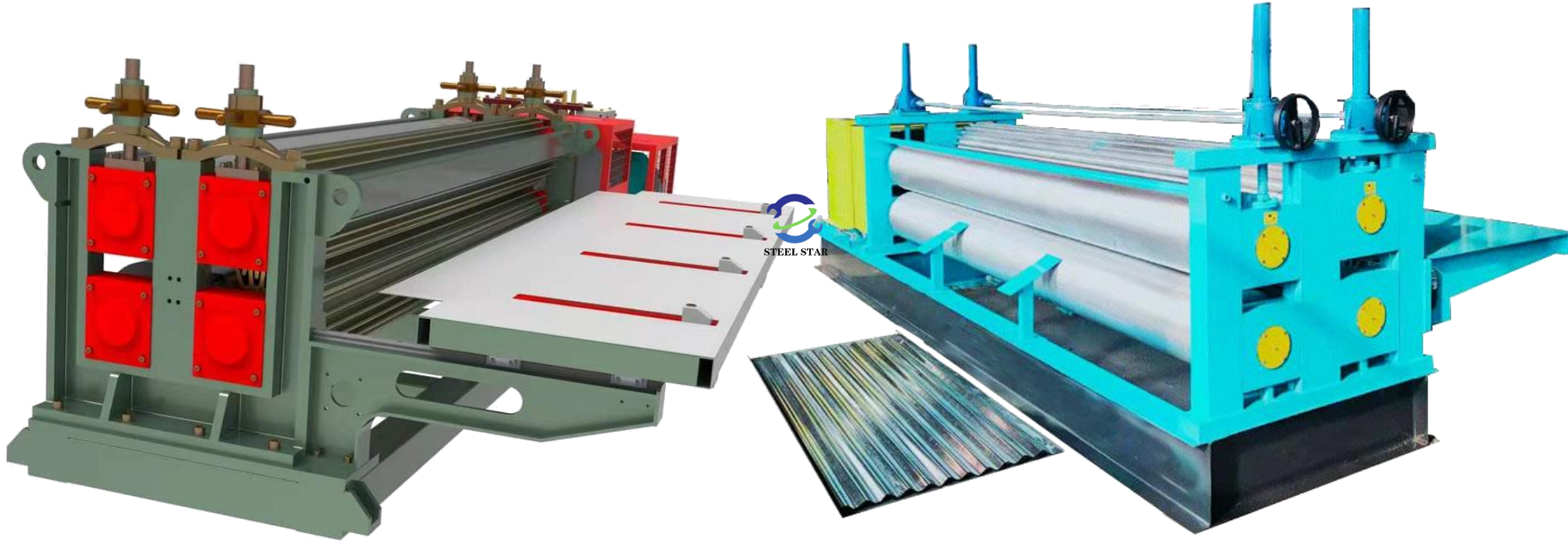



STEEL STAR
www.greatforming.com

Ürün Katalođu

7. Zemin Kaplama Rulo Şekillendirme Makinesi

7-1 Zemin Kaplama Rulo Şekillendirme Makinesi

Uygulama Senaryoları





STEEL STAR
www.greatforming.com

Ürün Katalođu

8. Otomobil Karton Rulo Şekillendirme Makinesi

8-1 Otomobil Karton Rulo Şekillendirme Makinesi

Uygulama Senaryoları

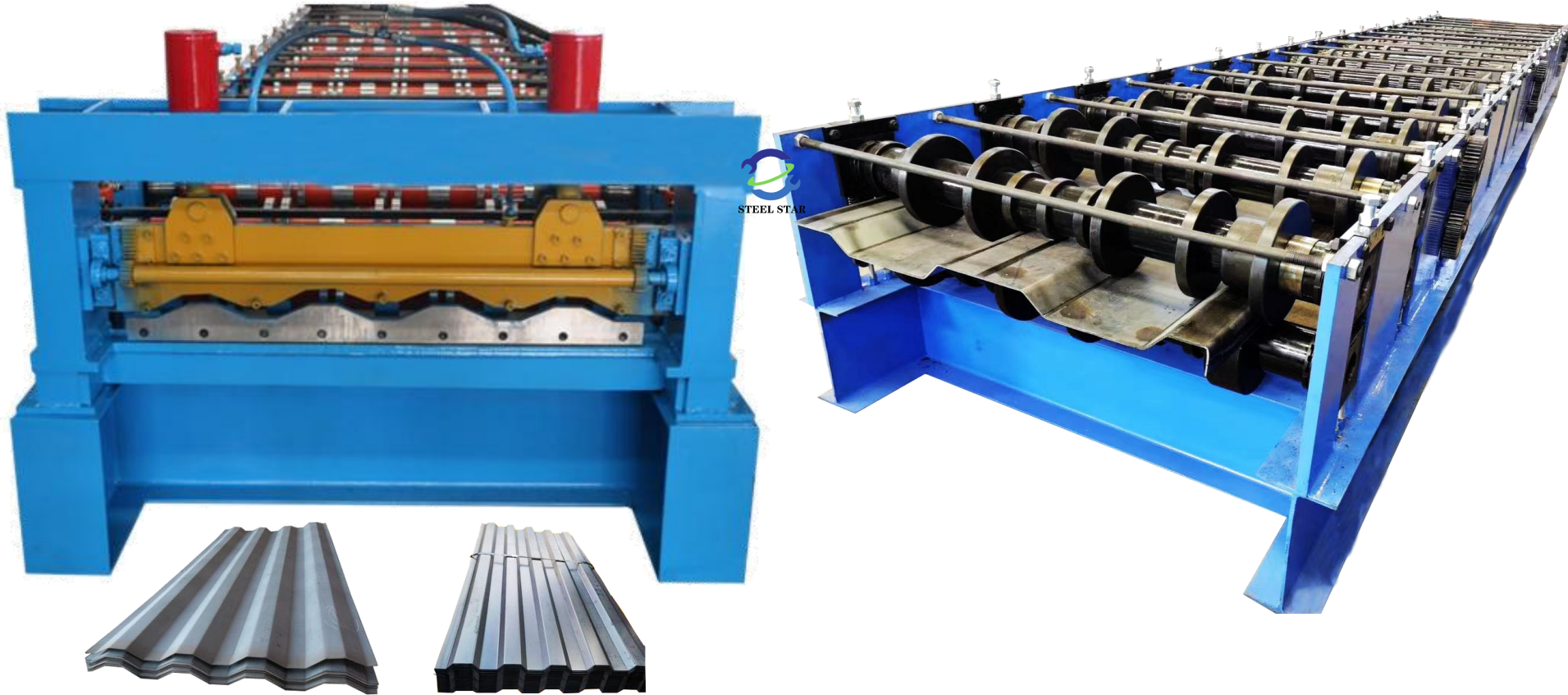



STEEL STAR
www.greatforming.com

Ürün Kataloğu

9. Yağmur Olukları / İniş Boruları Rulo Şekillendirme Makinesi

9-1 Yağmur Olukları / İniş Boruları Rulo Şekillendirme Makinesi

Uygulama Senaryoları

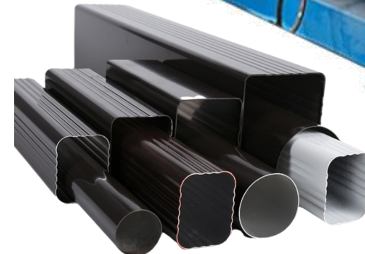
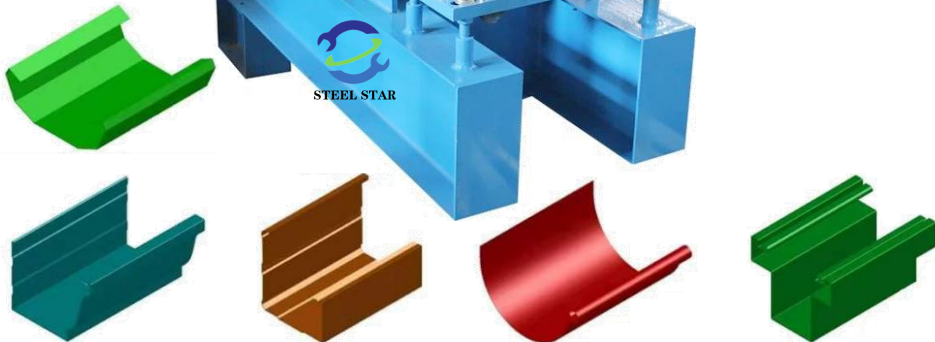



STEEL STAR
www.greatforming.com

Ürün Kataloğu

10. Hafif Keel Villa Çerçeve Rulo Şekillendirme Makinesi

10-1 Hafif Keel Villa Çerçeve Rulo Şekillendirme Makinesi

Uygulama Senaryoları

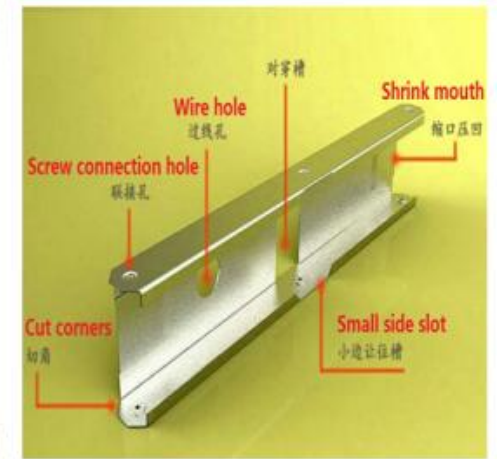
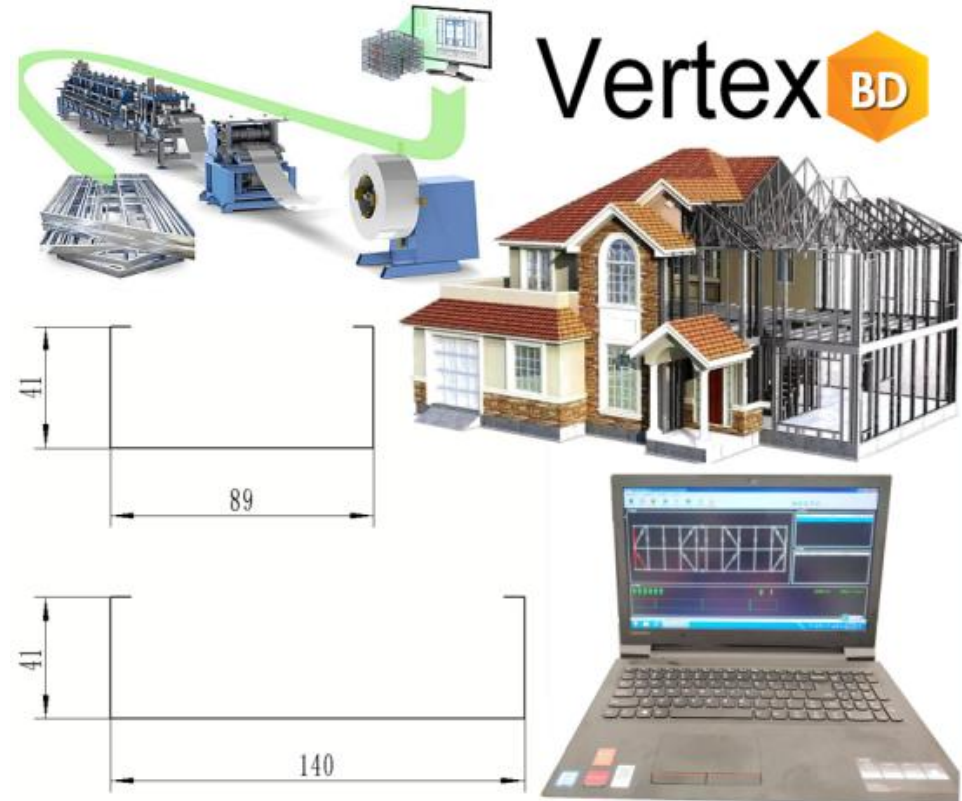



STEEL STAR
www.greatforming.com

Ürün Kataloğu

11. Korkuluk Plakası Rulo Şekillendirme Makinesi

11-1 Korkuluk Plakası Rulo Şekillendirme Makinesi

Uygulama Senaryoları

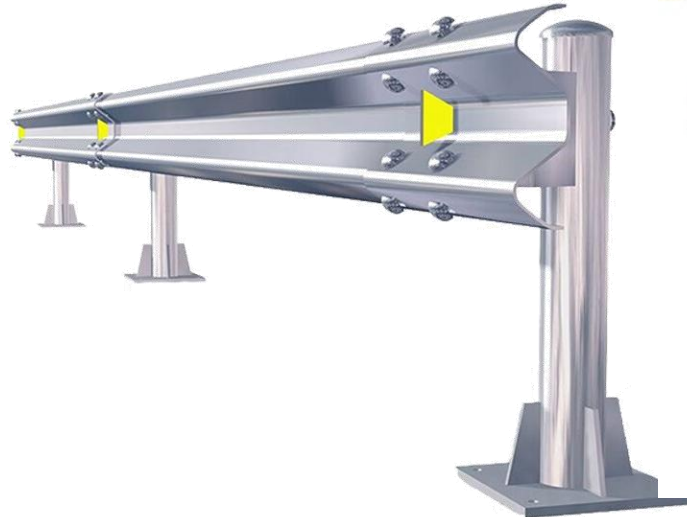
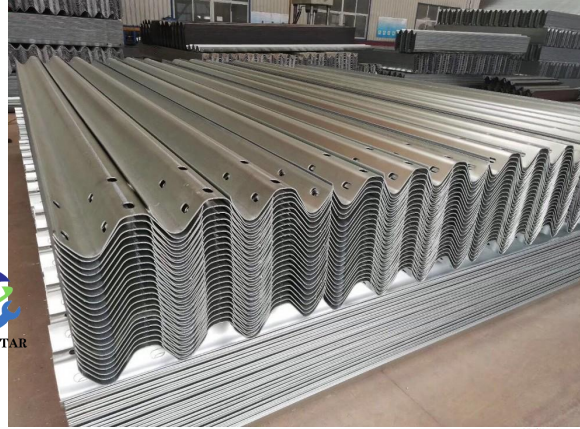



STEEL STAR
www.greatforming.com

Ürün Katalođu

12. EPS Köpük/Taş Yünü Çatı Levhası Kompozit Üretim Hattı

12-1 EPS Köpük/Taş Yünü Çatı Levhası Kompozit Üretim Hattı

Uygulama Senaryoları

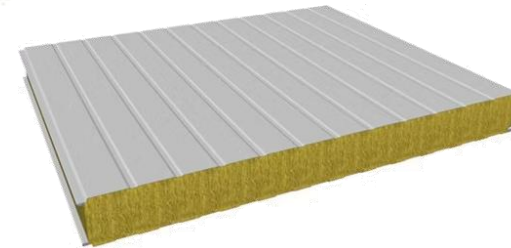
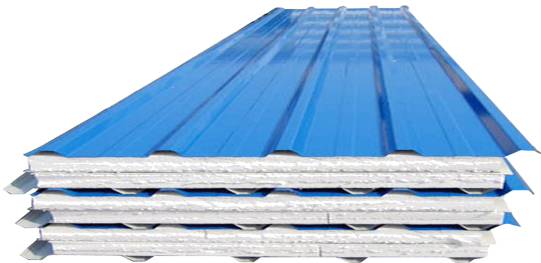



STEEL STAR
www.greatforming.com

Ürün Kataloğu

13. (PU) Poliüretan Sandviç Panel Üretim Hattı

13-1 (PU) Poliüretan Sandviç Panel Üretim Hattı

Uygulama Senaryoları

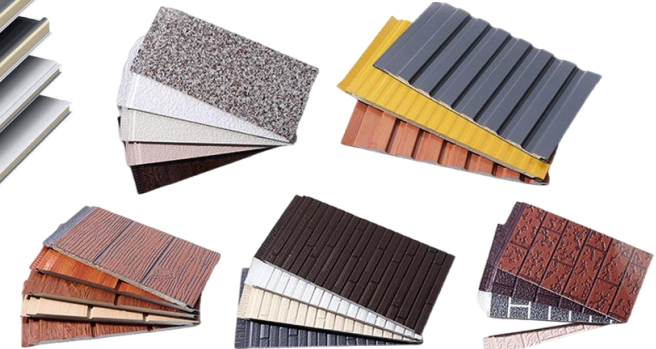
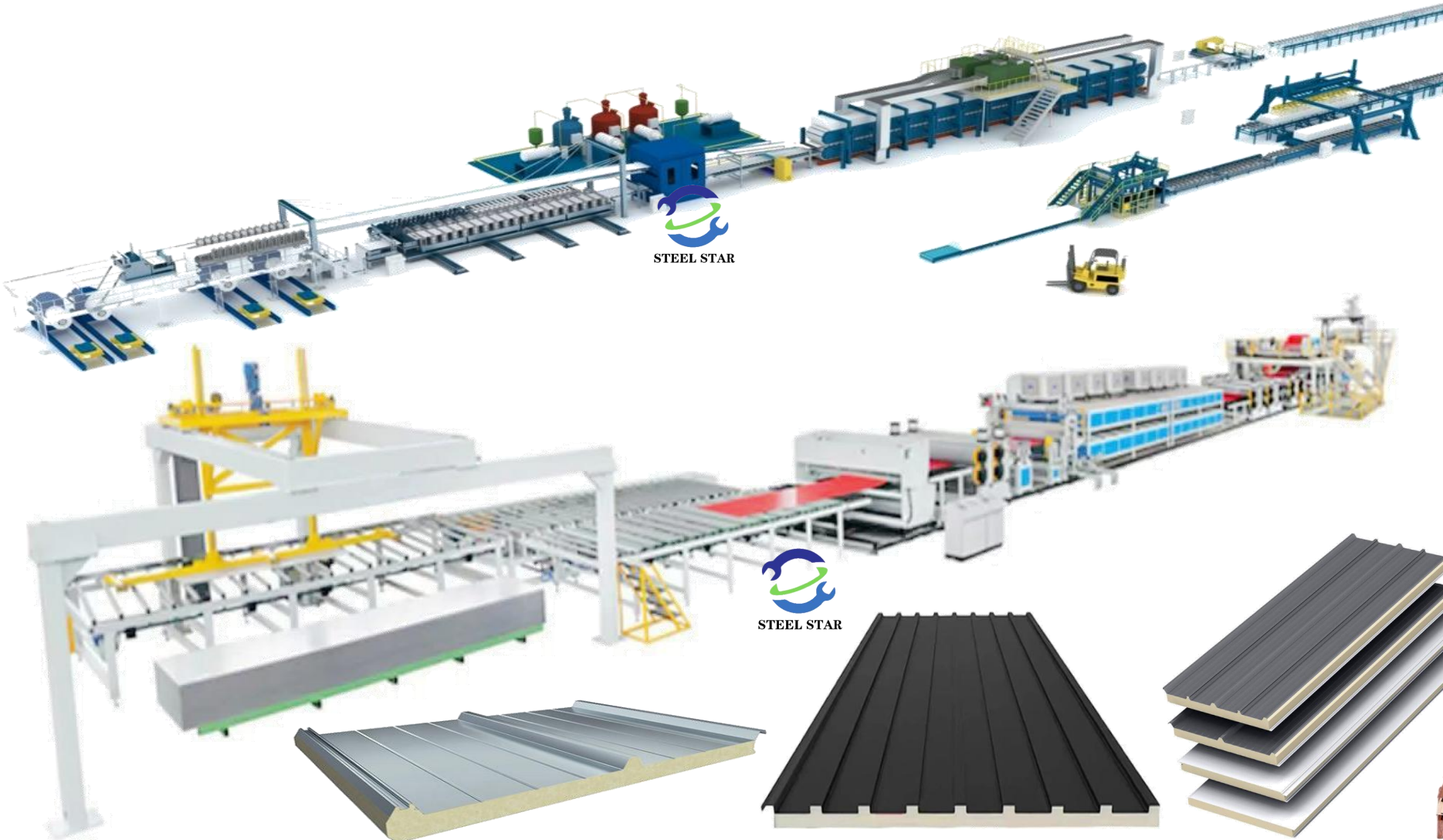



STEEL STAR
www.greatforming.com

Ürün Katalođu

14. Tavan Paneli Açma Makinesi / Otomatik İstifleme Makinesi

14-1 Tavan Paneli Açma Makinesi / Otomatik İstifleme Makinesi

Uygulama Senaryoları



STEEL STAR





STEEL STAR
www.greatforming.com

Ürün Katalođu

15. Bükme / Giyotin Kesme Makinesi

15-1 Bükme / Giyotin Kesme Makinesi

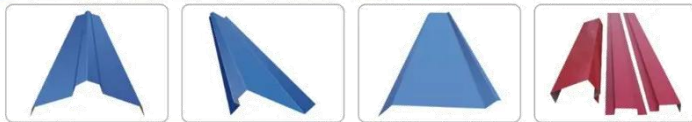
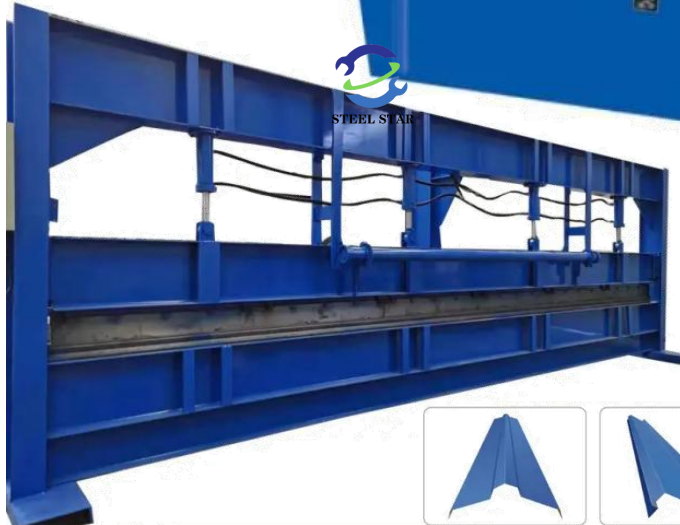
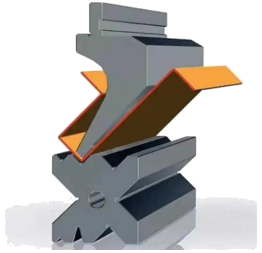



16-1 Çelik Bobin Dilme Hattı Makinesi

Uygulama Senaryoları

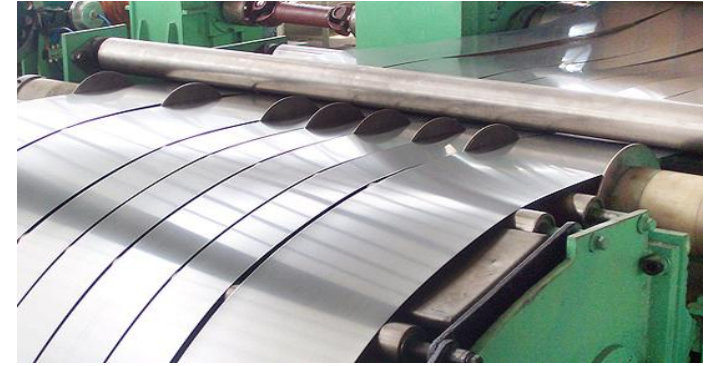



STEEL STAR
www.greatforming.com

Ürün Katalođu

17. Güneş Paneli Braketi Makinesi

17-1 Güneş Paneli Braketi Makinesi



Uygulama Senaryoları





18-1 Çelik Boru Üretim Makinesi



Uygulama Senaryoları

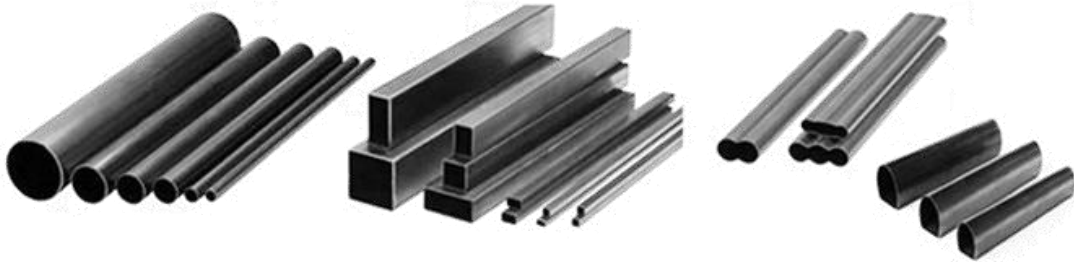



19-1 Raflı Rulo Şekillendirme Makinesi

Uygulama Senaryoları

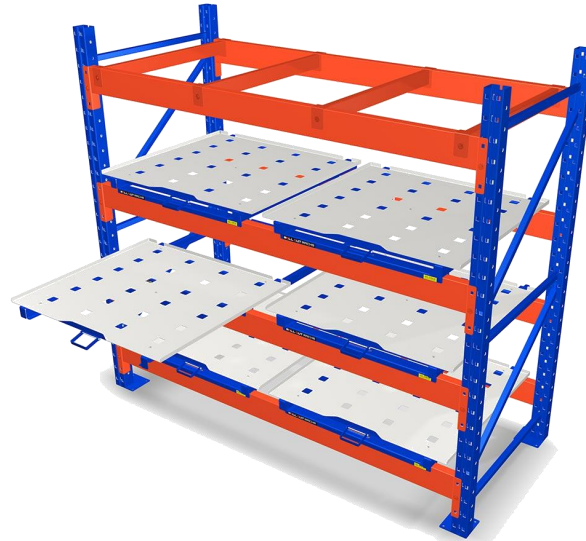
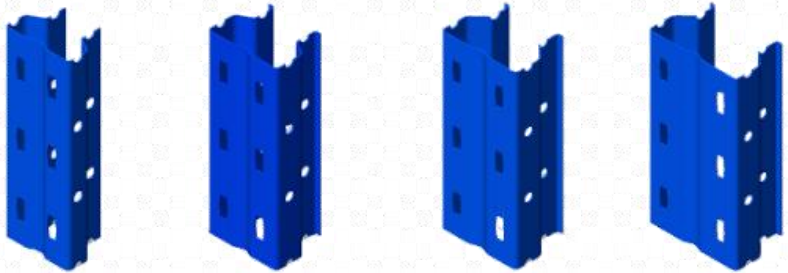
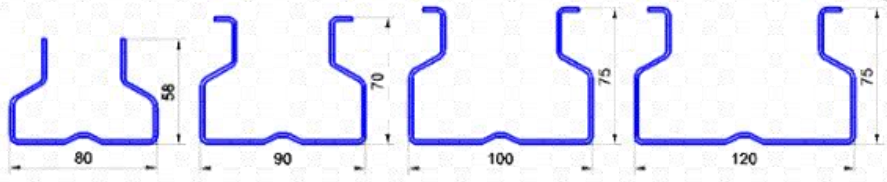



STEEL STAR
www.greatforming.com

Ürün Kataloğu

20. Kablo Kanalı Rulo Şekillendirme Makinesi

20-1 Kablo Kanalı Rulo Şekillendirme Makinesi

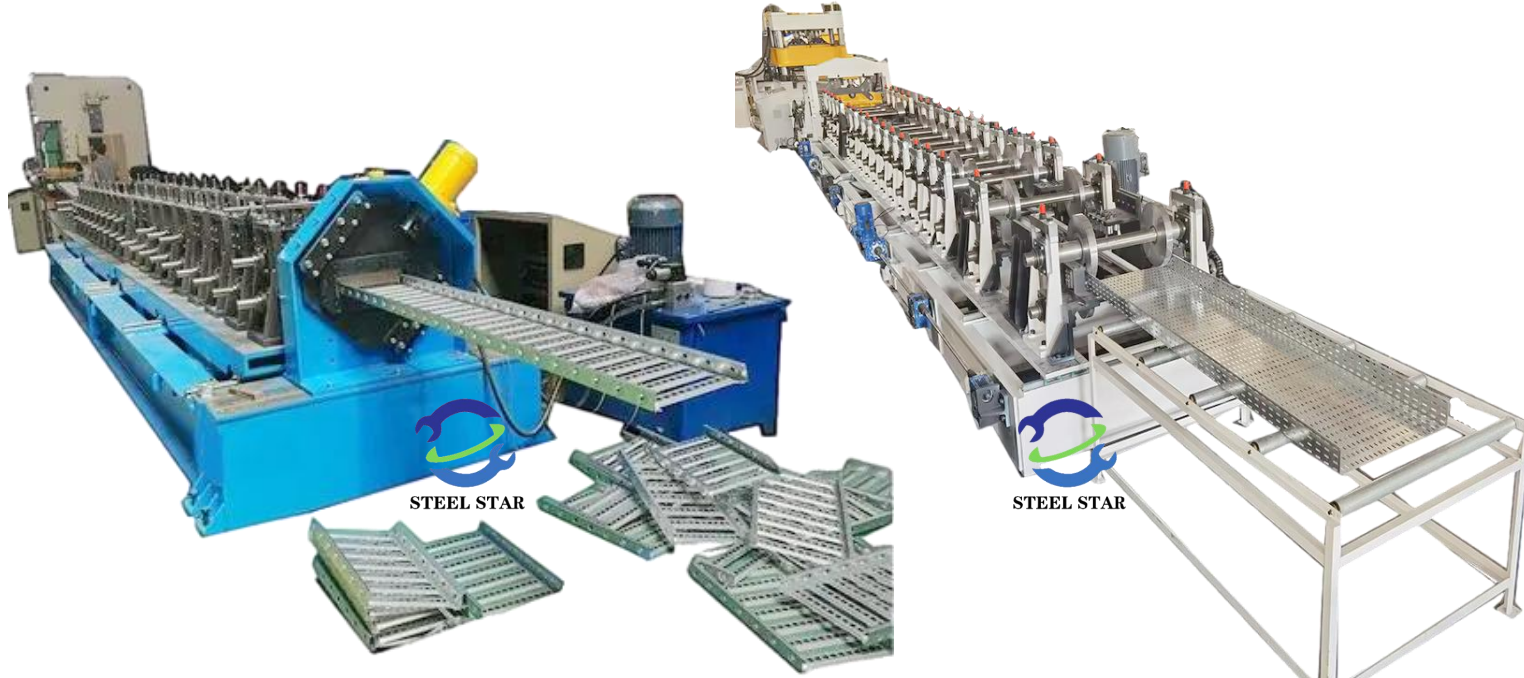

Uygulama Senaryoları





21-1 Metal Kabartma Hattı



Uygulama Senaryoları

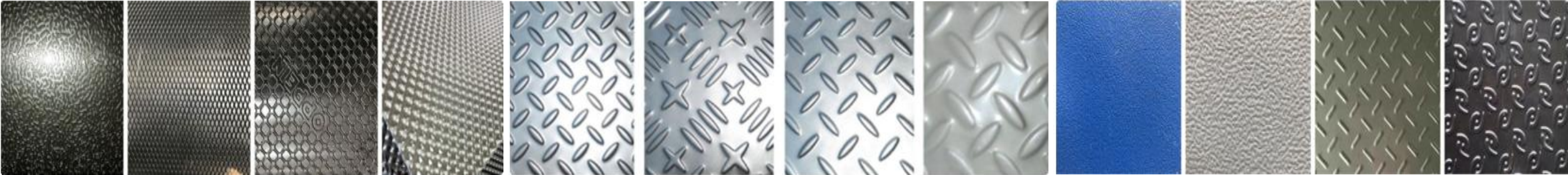
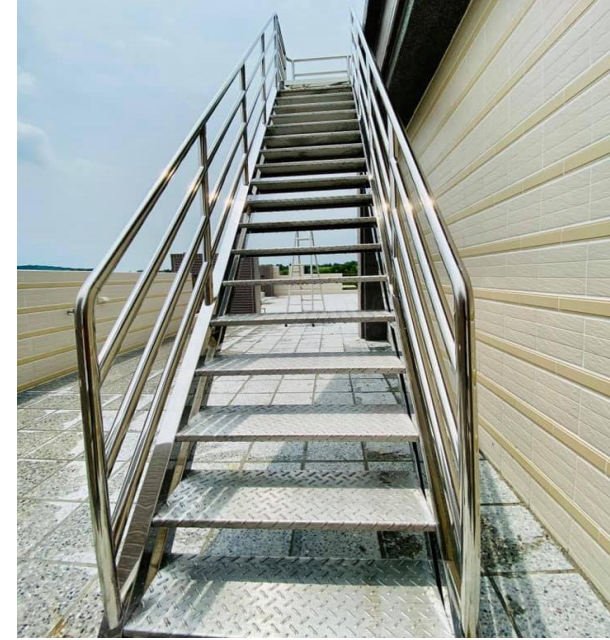



STEEL STAR
www.greatforming.com

Ürün Katalođu

22. Çit Diređi / Çit Çubukları Rulo Şekillendirme Makinesi

22-1 Çit Diređi / Çit Çubukları Rulo Şekillendirme Makinesi



Uygulama Senaryoları

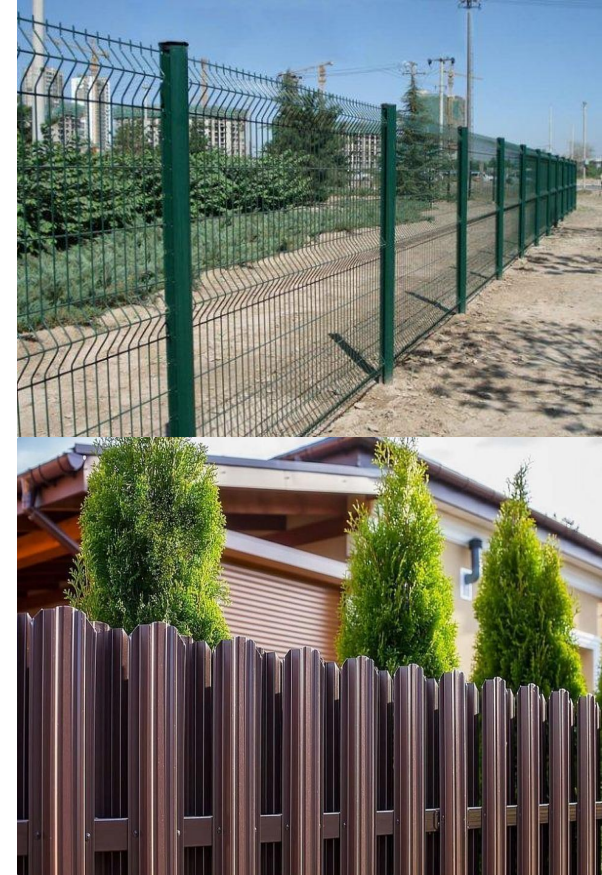



STEEL STAR
www.greatforming.com

Ürün Kataloğu

23. Silo Rulo Şekillendirme Makinesi

23-1 Silo Rulo Şekillendirme Makinesi

Uygulama Senaryoları

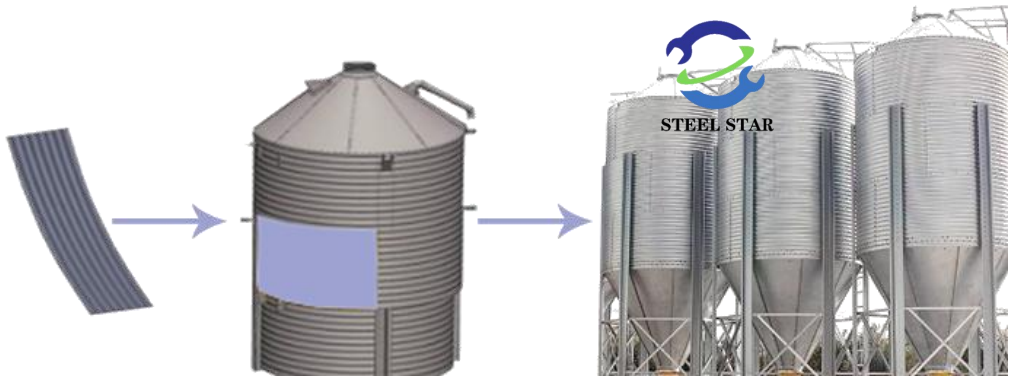
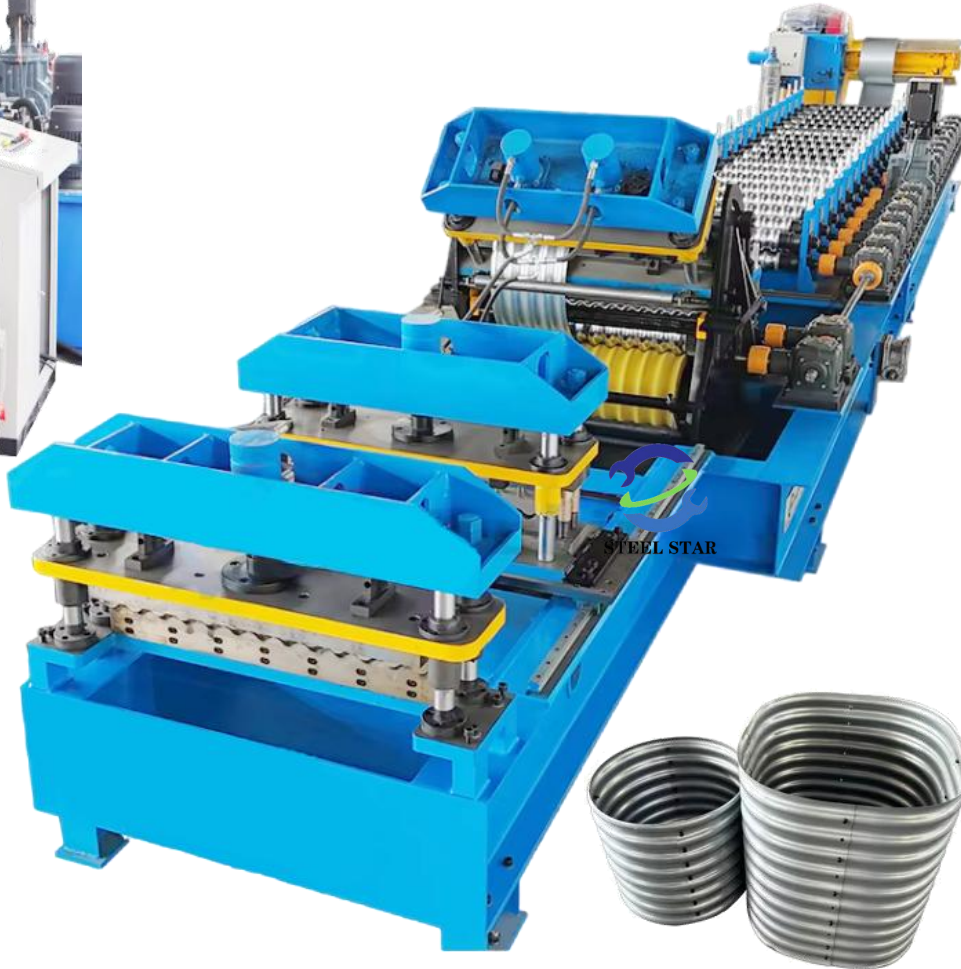
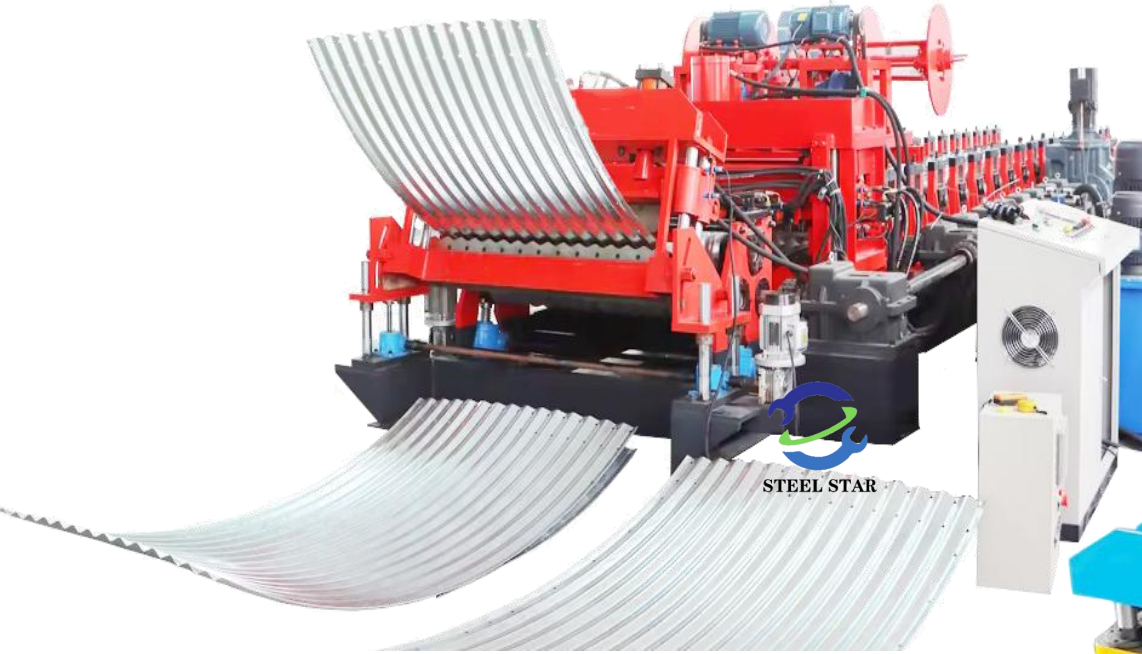



STEEL STAR
www.greatforming.com

Ürün Kataloğu

24. Ayak Pedallı Rulo Şekillendirme Makinesi

24-1 Ayak Pedallı Rulo Şekillendirme Makinesi



Uygulama Senaryoları





STEEL STAR
www.greatforming.com

Ürün Kataloğu

25. Dik Dikişli Rulo Şekillendirme Makinesi

25-1 Dik Dikişli Rulo Şekillendirme Makinesi



STEEL STAR

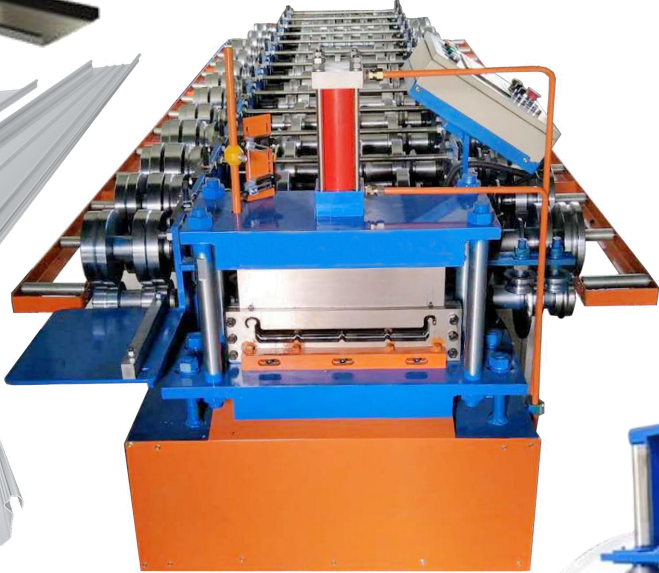

STEEL STAR

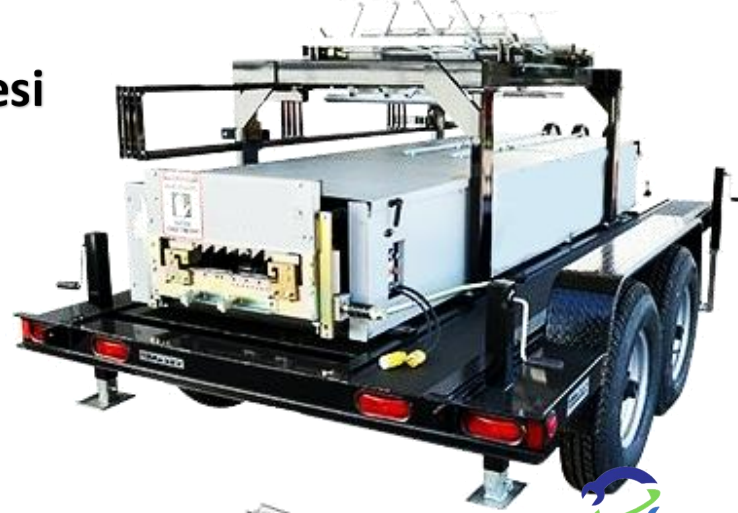

STEEL STAR

Uygulama Senaryoları





STEEL STAR
www.greatforming.com

Product Catalog

26. Taş Kaplı Çatı Kiremiti Üretim Makinesi

26-1 Taş Kaplı Çatı Kiremiti Üretim Makinesi Püskürtme Taş Kaplama

Uygulama Senaryoları

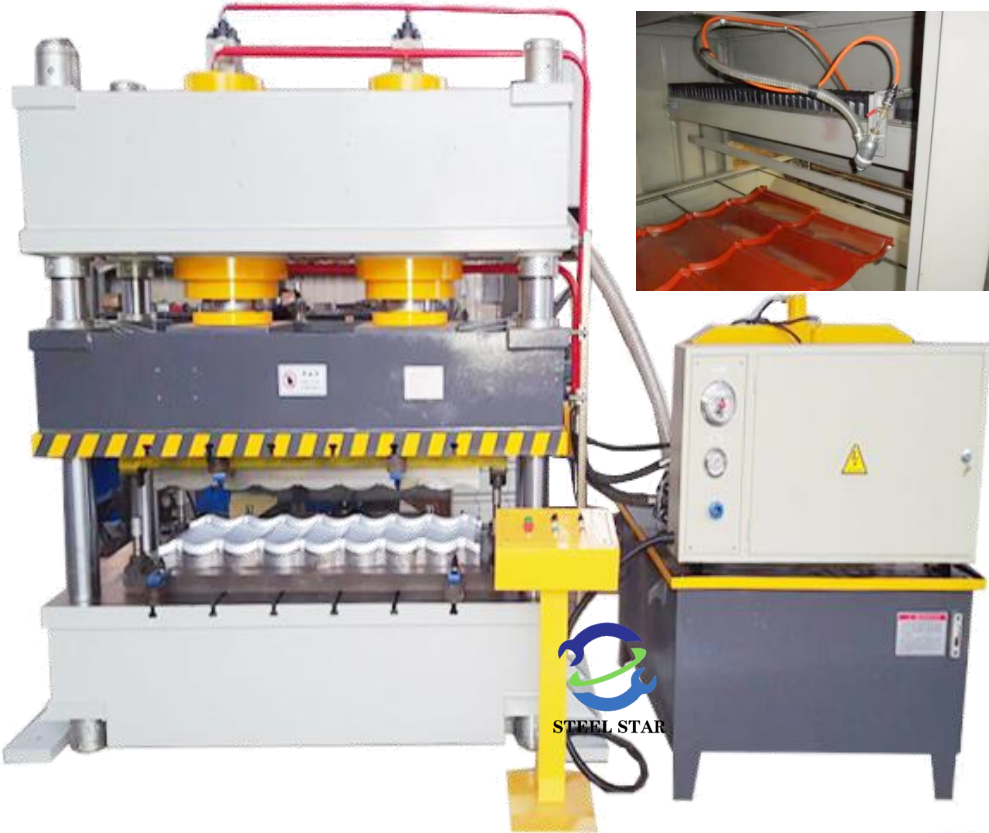

27-1 Çeşitli Ürünler Kişiselleştirilebilir

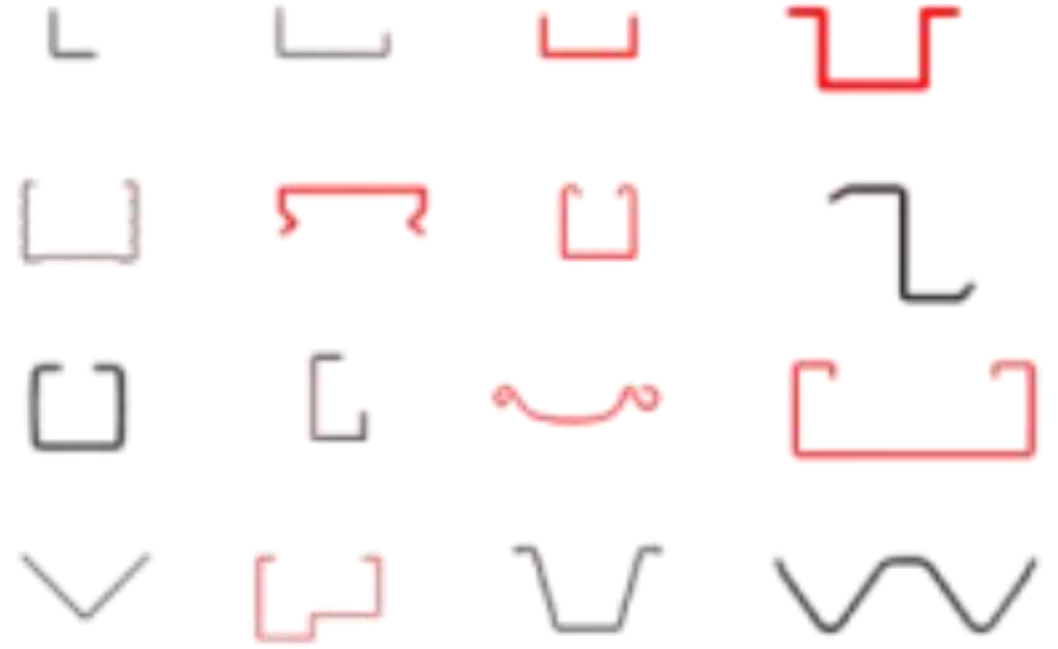
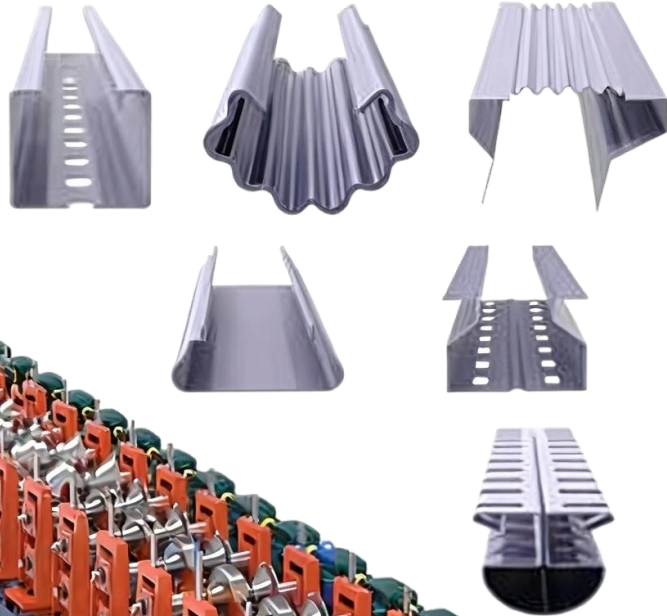
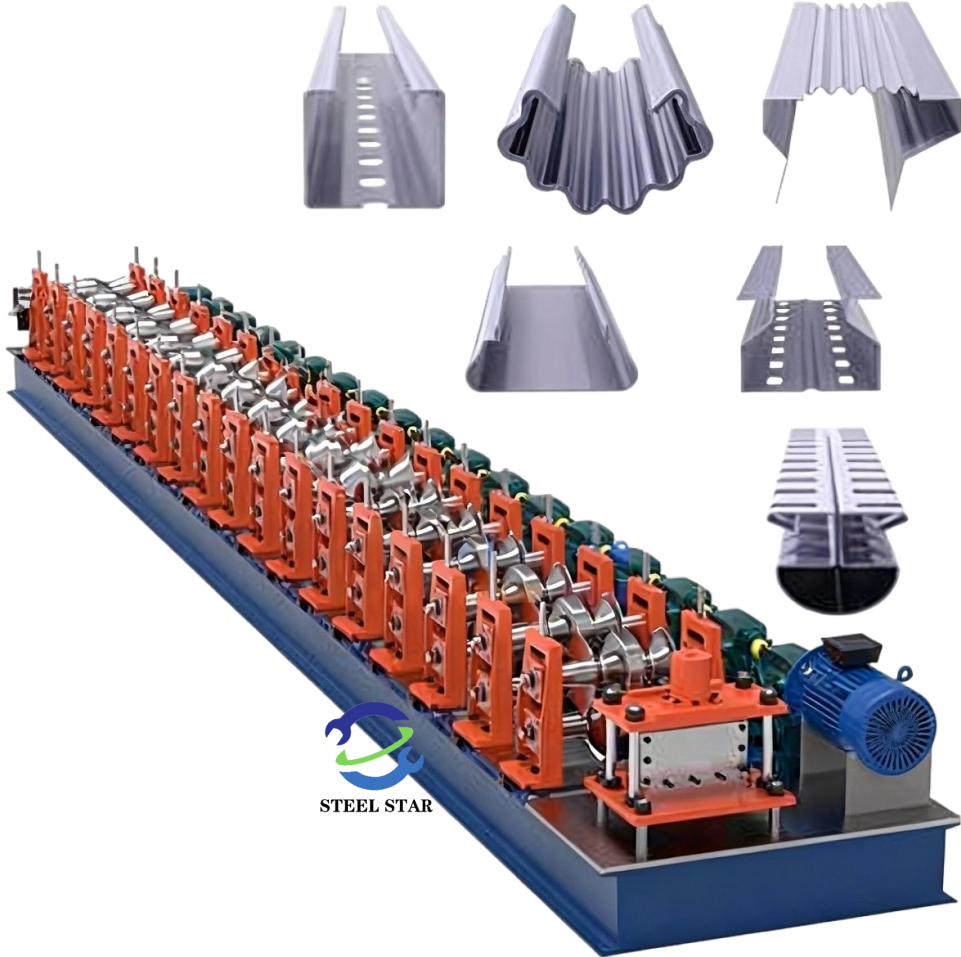



STEEL STAR
www.greatforming.com

Yurtdışına Nakliye





STEEL STAR
www.greatforming.com

Hizmet



Müşteri hizmetlerimiz, sistemle ilgili her türlü sorununuzu çözenize yardımcı olacaktır: hizmetimiz hafta içi 24 saat boyunca mevcuttur. Sorularınıza hızlı ve güvenilir bir şekilde cevap vereceğiz.

Gerekirse, şehrinize gelip ekipmanın yerinde kurulumunda size yardımcı olabilecek profesyonel hata ayıklama ve kurulum personeli göndereceğiz.





STEEL STAR
www.greatforming.com

Bize Ulaşın



+86 15075780050

WhatsApp Wechat

E-posta(Email) : sam@greatforming.com

Resmi Web Sitesi : www.turkishgreatforming.com

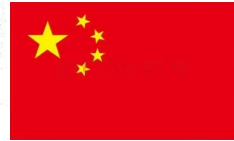

China



Beijing		1 Hour	
		4 Hour	

Tianjin		0.5 Hour	
		2.5 Hour	

Jinan		1 Hour	
		3 Hour	